

# Simpa®

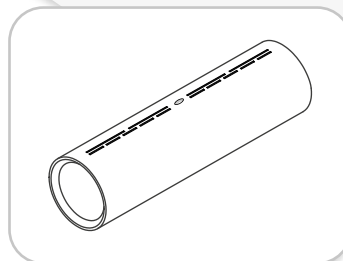

**JANUARY 2025**

# CERTIFICATES AND DOCUMENTS

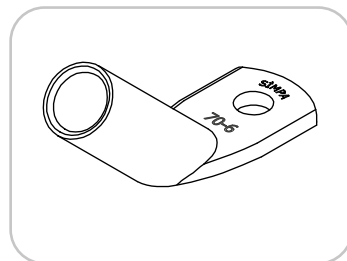
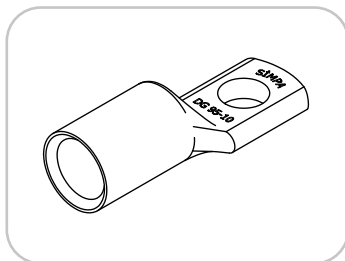
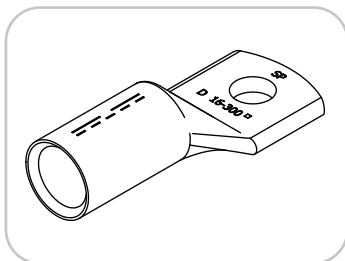
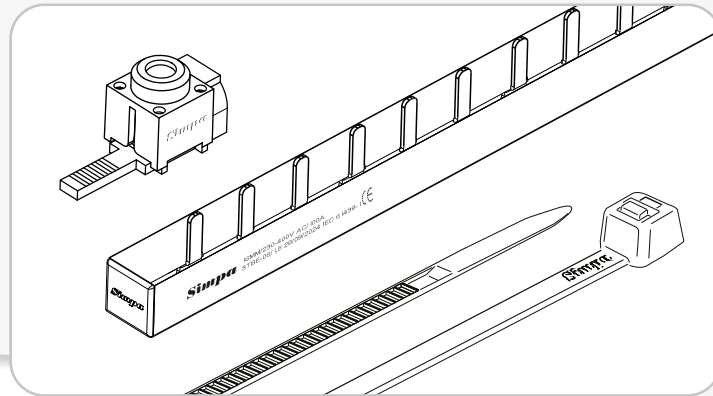
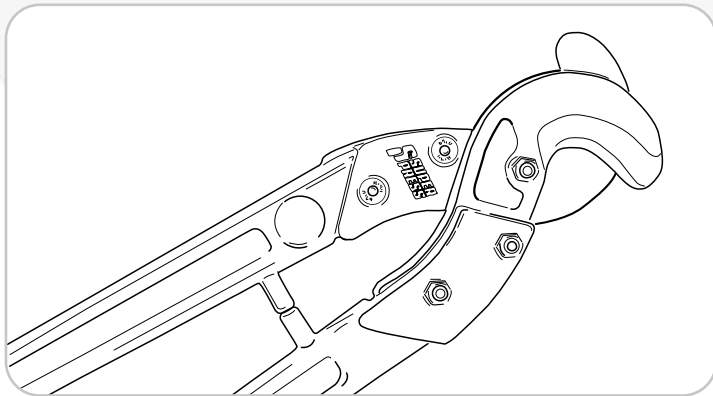

## TÜRK STANDARLARI ENSTİTÜSÜ TÜRK STANDARLARINA UYGUNLUK BELGESİ TURKISH STANDARDS INSTITUTION CERTIFICATE OF CONFORMITY TO TURKISH STANDARDS

Markanın Tanımı Description of the Mark  
TSE  

BELGE NUMARASI REFERENCE NUMBER OF LICENCE	007931-TSE-02/03
BELGENİN İLK VERİLEŞ TARİHİ DATE OF FIRST ISSUE OF LICENCE	12.01.2015
BELGENİN SON GEÇERLİLİK TARİHİ LICENCE VALID UNTIL	21.09.2025
BELGE SAHİBİ KURULUŞUN ADI NAME OF THE LICENCE HOLDER	SİMPA ELEKTRİK MALZEMESİ SANAYİ VE TİCARET ANONİM ŞİRKETİ
BELGE SAHİBİ KURULUŞUN ADRESİ ADDRESS OF THE LICENCE HOLDER	DUDULLU OSB MAH. DES-105 SK. DES B-11 NO.14/D ÜMRANIYE İSTANBUL/TÜRKİYE
ÜRETİM YERİ ADI NAME OF THE MANUFACTURING PLACE	SİMPA ELEKTRİK MALZEMESİ SANAYİ VE TİCARET ANONİM ŞİRKETİ
ÜRETİM YERİ ADRESİ ADDRESS OF THE MANUFACTURING PLACE	DES SANAYİ SİTESİ 105 SK. B.11 BLOK NO:16 Y. DUDULLU İSTANBUL / TÜRKİYE
İPTAL EDİLEN BELGE NUMARASI (Varsa) INDICATION OF SUPERSEDED LICENCE (if any)	007931-TSE-02/02
TESCİLLİ TİCARİ MARKASI REGISTERED TRADE MARK	simpa
İLGİLİ TÜRK STANDARTI RELATED TURKISH STANDARD	TS EN IEC 61238-1-3 / 16.12.2019 – TS EN IEC 61238-1-3/A1 / 16.12.2019
BELGE KAPSAMI SCOPE OF LICENCE	(SİKTİRMELİ) BAĞLAYICILAR-GIRIF A SİKP-A,SİKP-B,SİKP-C,SİKP-D,SİKP-E,SİKP-F,SİKP-G,SİKP-H,SİKP-I,SİKP-J,SİKP-K,SİKP-L,SİKP-M,SİKP-N,SİKP-O,SİKP-P,SİKP-Q,SİKP-R,SİKP-S,SİKP-T,SİKP-U,SİKP-V,SİKP-W,SİKP-X,SİKP-Y,SİKP-Z -10 mm <sup>2</sup> (DAH) / DEN 300 mm <sup>2</sup> (DAH) / a kadar SEM-A,SEM-D Model (EK MUFARJ) Bakır/Dü -10 mm <sup>2</sup> (DAH) / DEN 300 mm <sup>2</sup> (DAH) / a kadar AKP-D,AKP-DH,AKP-DK Model Alüminyum (A) Kablo Papazları -16 mm <sup>2</sup> (DAH) / DEN 300 mm <sup>2</sup> (DAH) / a kadar, (K.D.28.11.2017) ADM-D Model (EK MUFARJ) - Alüminyum (A) -16 mm <sup>2</sup> (DAH) / DEN 300 mm <sup>2</sup> (DAH) / a kadar, (K.D.28.11.2017)

e-imza ile onaylandı  
20.09.2024  
Belgelendirme Merkezi Başkanı Adına  
AKDOĞAN BULUT  
İSTANBUL BELGELENDİRME MÜDÜRÜ V.

\*Bu belge, belgelendirilen ürünün, üretim yerinin, Enerji Tüketim oranının ve diğer teknik gerekliliklerin de gösterilmesidir.  
\*Bu belge, bir başka belgeyle birlikte, eşitlik veya devamlılık şartlarında geçerli değildir. İzlenim ve bilgi gerektirir.  
\*TSE (TANITILMIŞ BELGELENDİRME MERKEZİ) \* Adres: Çarşıbaşı Tarih Sokakı No:105/11 Ümraniye / İstanbul / Türkiye / Telefon: 0212 418 66 81 / 418 66 17 / E-posta: info@tse.org.tr - web: www.tse.org.tr  
\*TSE BELGELENDİRME MERKEZİ BAŞKANLIĞI - Adres: Necatibeyi Cad. No:112/20/20 Sakarya Sokakı/Beşiktaş - İstanbul / 0212 418 66 81 / 418 66 17 / E-posta: info@tse.org.tr - web: www.tse.org.tr

<https://www.kontrast.tse.org.tr/BelgeDetaylari.aspx?ID=007931-TSE-02/03>  1 / 1



Management Service

# CERTIFICATE

Certificate Registration No.: 12 100 37688 TMS / Order No.: 712926457

The Certification Body of TÜV SÜD Management Service GmbH certifies that the organization

## Simpa®

**SİMPA ELEKTRİK MALZEMESİ SAN. VE TİC. A.Ş.**  
DES SANAYİ SİTESİ 105 (YAPRAK) SOK. B11 BLOK NO:16  
34776 Y. DUDULLU - ÜMRANIYE- İSTANBUL  
Turkey

for the scope

**MANUFACTURING AND SALES OF  
ELECTRIC CRIMPS AND BUS BARS**

has established and applies a Quality Management System.  
An audit was performed and has furnished proof that the requirements according to

**DIN EN ISO 9001:2015**

are fulfilled.  
The certificate is valid from **2025-02-04** until **2028-02-03**.

  
Fred Wenke  
Head of Certification Body  
Munich, 2025-02-04



TÜV SÜD Management Service GmbH • Zertifizierungsstelle • Röllnerstraße 57 • 80339 München • Germany  
[www.tuv.sud.com/de/certificate-validity-check](http://www.tuv.sud.com/de/certificate-validity-check) 



## EC DECLARATION OF CONFORMITY (AT) UYGUNLUK BEYANI

**İMALATÇI (MANUFACTURER)**  
SİMPA ELEKTRİK MALZEMESİ SAN. VE TİC. A.Ş.  
DES SANAYİ SİTESİ 105 SK. B.11 BLOK NO: 16 Y.DUDULLU-ÜMRANIYE- İSTANBUL- TÜRKİYE

**ÜRÜN TANIMI (PRODUCT DESCRIPTION)**  
"SİMPA" MARKALI  
İZOLELİ OTOMAT BESEME BARLARI (ISOLATED COMB BUSBARS)

**MODELLER (MODELS)**  
MONOFAZE ERKEK İZOLELİ BARLAR (1 PHASE INSULATED COMB BUSBARS PIN TYPE)  
1 TBE-12/1,5, 1 TBE-18/1,5, 1 TBE-24/1,5, 1 TBE-30/1,5, 1 TBE-M1/1,5

(2) FAZLI ERKEK İZOLELİ BARLAR (2 PHASE INSULATED COMB BUSBARS PIN TYPE)  
2 TBE-06/1,0, 2 TBE-09/1,0, 2 TBE-12/1,0, 2 TBE-15/1,0, 2 TBE-18/1,0, 2 TBE-24/1,0, 2 TBE-30/1,0, 2 TBE-06/1,5, 2 TBE-09/1,5, 2 TBE-12/1,5, 2 TBE-15/1,5, 2 TBE-M1/1,5

TRİFAZE ERKEK İZOLELİ BARLAR (3 PHASE INSULATED COMB BUSBARS PIN TYPE)  
3 TBE-04/1,0, 3 TBE-06/1,0, 3 TBE-08/1,0, 3 TBE-10/1,0, 3 TBE-12/1,0, 3 TBE-14/1,0, 3 TBE-16/1,0, 3 TBE-18/1,0, 3 TBE-20/1,0, 3 TBE-24/1,0, 3 TBE-30/1,0, 3 TBE-04/1,5, 3 TBE-06/1,5, 3 TBE-08/1,5, 3 TBE-10/1,5, 3 TBE-M1/1,5

TRİFAZE DİŞİ İZOLELİ BARLAR (3 PHASE INSULATED COMB BUSBARS FORK TYPE)  
3 TBO-04/1,0, 3 TBO-06/1,0, 3 TBO-08/1,0, 3 TBO-10/1,0, 3 TBO-12/1,0, 3 TBO-14/1,0, 3 TBO-16/1,0, 3 TBO-18/1,0, 3 TBO-20/1,0, 3 TBO-24/1,0, 3 TBO-30/1,0, 3 TBO-04/1,5, 3 TBO-06/1,5, 3 TBO-08/1,5, 3 TBO-10/1,5, 3 TBO-M1/1,5

DÖRT FAZLI ERKEK İZOLELİ BARLAR (3 FAZ + 1 NÖTR) (4 PHASE INSULATED COMB BUSBARS PIN TYPE)  
4 TBE-04/1,5, 4 TBE-08/1,5, 4 TBE-M1/1,5

**UYGULANAN STANDARTLAR (APPLICABLE STANDARDS)**

- TS EN 61439-1:2011  
Alçak gerilim anahtarlar ve kontrol düzeni donanımları - Bölüm 1: Genel kuralları  
(Low-voltage switchgear and controlgear assemblies - Part 1: General rules)
- TS EN 61439-2:2011 (İngilizce Metin)  
Alçak gerilim anahtarlar ve kontrol düzeni donanımları - Bölüm 2: Güç anahtarlar ve kontrol düzeni donanımları  
(Low-voltage switchgear and controlgear assemblies - Part 2: Power switchgear and controlgear assemblies)

**UYGULANAN YÖNETMELİKLER (APPLICABLE DIRECTIVES)**

- Belirli Gerilim Sınırları Dahilinde Kullanılmak Üzere Tasarlanmış Elektrikli Teşviat İle İlgili Yönetimlik  
(2006/95/AT) - (2006/95/AT) Low Voltage Directive

Yukarıda marka, model ve bilgileri verilen ve aşağı başlığında örneği olan CE işaretli ürünler, piyasaya arz edilen ürünlerin ilgili standartlara ve direktiflere uygun olarak üretilmiş, insan sağlığı, can ve mal güvenliği, hayvan ve baki yaşam ve sağlığı, çevre ve tüketicinin korunması açısından sağlanması gereken asgari güvenlik koşullarını sağladığını beyan ederiz.

The undersigned company certifies under its sole responsibility that the item of equipment specified above satisfies the requirements of the relevant standards and directives which are applied to them.



CE Markası ilgilirdiği yılın son iki rakamı : 12  
Date of affixing CE mark on the product

**YER, TARİH (PLACE, DATE)**  
İstanbul, 16.10.2014

**YETKİLİ İMZA (PLACE, DATE)**  
İsim Soyad **ARTUN ÖZAYDIN**  
Genel Müdür  
General Manager 



Deutsche  
Akkreditierungsstelle

## Deutsche Akkreditierungsstelle GmbH

Entrusted according to Section 8 subsection 1 AkkStellG in connection with Section 1 subsection 1 AkkStellG/BV Signatory to the Multilateral Agreements of EA, ILAC and IAF for Mutual Recognition

## Accreditation



The Deutsche Akkreditierungsstelle GmbH attests that the Certification Body for Management Systems

**TÜV SÜD Management Service GmbH**  
Ridlerstraße 57  
80339 München  
(including the sites as listed in the annex)

it competent under the terms of DIN EN ISO/IEC 17021-1:2015 to carry out certifications of management systems in the following fields:

DIN EN ISO 9001:2015 Quality Management Systems  
DIN EN ISO 14001:2015 Environmental Management Systems  
DIN EN ISO 45001:2018 Occupational health and safety management systems  
ISO/IEC 20000-1:2018 - Information Technology - Service Management - Part 1: Service management system requirements  
DIN EN ISO/IEC 27001:2017 Information technology - Security techniques - Information security management systems  
DIN ISO 29990:2010 Learning services for non-formal education and training; DIN EN ISO 30001:2018 Energy Management Systems  
The catalogue of IT security requirements under section 11 (1a) of the Energy Act and Conformity Assessment Program of Bundesnetzagentur dated 16<sup>th</sup> November 2017 for Electricity and Gas Supply Sector  
MAAS-BGW-scheme for occupational health and safety management systems (version 06/2017)  
SCC-scheme for SHE-Management Systems according to DGK/B Version 2011  
BS OHSAS 18001:2007 Occupational Health and Safety Management Systems

The accreditation certificate shall only apply in connection with the notice of accreditation of 12.06.2020 with the accreditation number D-ZM-14143-01. It comprises the cover sheet, the reverse side of the cover sheet and the following annex with a total of 6 pages.

Registration number of the certificate: D-ZM-14143-01-00

Berlin, 12.06.2020   
Dipl.-Ing. Ina Stübgenrauch  
Head of Division  
Registration issued:  
12.06.2020

The certificate together with its annex reflects the status at the time of the date of issue. The current status of the scope of accreditation can be found in the database of accredited bodies of Deutsche Akkreditierungsstelle GmbH.  
<https://www.dakks.de/en/Content/ accredited-bodies-dakks>

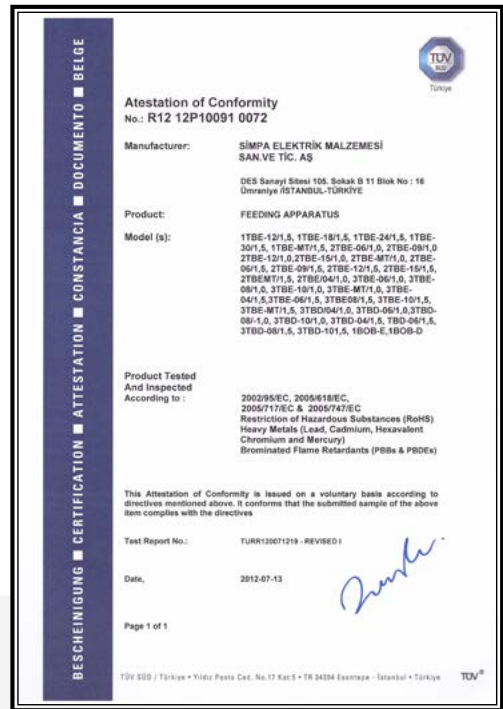
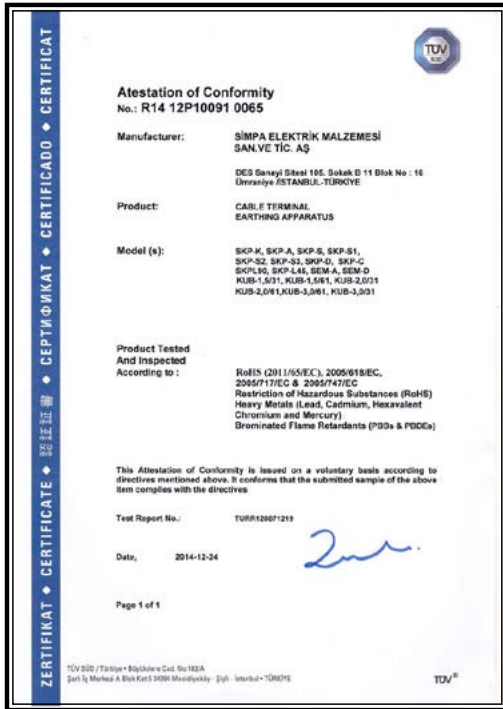





































TRADE POLICIES

- WE RESERVE THE RIGHTS TO CHANGE THE CODES, THE MEASUREMENTS AND THE PRICES OF CATALOG PRODUCTS, WITHOUT ANY WARNING.
- RETURN IS NOT POSSIBLE WITHOUT PRIOR AGREEMENT.
- CONSIGNMENT CHARGE BELONGS TO THE BUYER.
- VAT TAX IS NOT INCLUDED IN OUR PRICES, IT'S ADDITIONAL.

BASIC REFERENCE MODEL

TYPE OF CABLE LUG	CABLE SECTION (mm <sup>2</sup> ) - BOLT SIZE (METRIC)	STANDARD BOLT HOLE
SKP-A	150-M12	SD

# INDEX

	<b>SKP-E</b> Economic type tubular cable lugs	5		<b>BKP-D</b> Bimetallic cable lugs (AL-CU)	35
	<b>SKP-A</b> Visible type tubular cable lugs	6		<b>BEM-D</b> Bimetallic butt connectors (AL-CU)	36
	<b>SKP-S</b> Standard type tubular cable lugs	8		<b>BPK-D</b> Bimetallic pin type connectors (AL-CU)	37
	<b>SKP-S1</b> Europe type tubular cable lugs	10		<b>1/2/3/4 TBE / KUB</b> Insulated - non insulated busbars and terminals	38
	<b>SKP-S2</b> Long barrel tubular cable lugs	12		<b>SP-KM/250/500 - KMC/500</b> Mechanical Cable Cutters	43
	<b>SKP-S3</b> Longer barrel tubular cable lugs	14		<b>SP-KBB / KBS</b> Cable ties and accessories	44
	<b>SKP-D</b> DIN 46235 type tubular cable lugs	16		<b>SP-KY</b> Non insulated cable end-sleeves	47
	<b>SKP-D1</b> DIN 46234 type cable lugs	18		<b>SP-IKY</b> Insulated cable end-sleeves	48
	<b>SKP-GD</b> Tubular cable lugs with inspection hole	20		<b>SP-IKY/2</b> Insulated twin cable end-sleeves	49
	<b>SKP-DG</b> Tubular cable lugs for switch gear connections	21		<b>SP-YK/SP-CK</b> Insulated ring and fork type terminals	50
	<b>SKP-L90-S1</b> Europe type 90° angular cable lugs	22		<b>SP-FD/SP-FE</b> Insulated receptacles and tabs	52
	<b>SKP-L45-S1</b> Europe type 45° angular cable lugs	24		<b>SP-IFD</b> Fully Insulated receptacles	53
	<b>SKP-C</b> Tubular cable lugs with two connection holes	26		<b>SP-FEG</b> Insulated receptacles, multi type	53
	<b>SEM-A / SEM-S1 / SEM-D</b> Standard/Europe/ DIN 46267-1 type butt connectors	28		<b>SP-IK</b> Insulated pin type connectors	54
	<b>SKP-F</b> Fork type tubular cable lugs	30		<b>SP-IBU</b> Insulated blade type terminals	54
	<b>AKP-D</b> DIN 46329 type Aluminium cable lugs	31		<b>SP-IEM</b> Insulated butt connectors	54
	<b>AKP-DY</b> Aluminium cable lugs with oxide protection oil	32		<b>SP-ET</b> Insulated bullet connectors	55
	<b>AKP-DK</b> Aluminium cable lugs with oxide protection oil	33		<b>SP-DT</b> Insulated female bullet connectors	55
	<b>AEM-D</b> DIN 46267-2 type aluminium butt connectors	34			

# SKP-E

## ECONOMIC TYPE TUBULAR CABLE LUGS

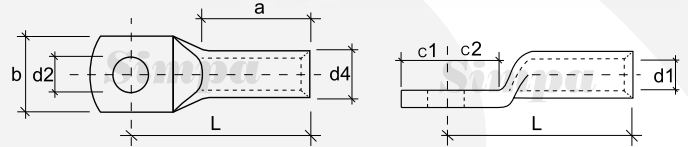

All rights reserved.

Order Code	Cable Section (mm <sup>2</sup> )	Bolt	Dimensions								Box Pcs.	Box Weight	Parcel Pcs.	Box Weight
			d1	d4	a	d2	b	c1	c2	L				
SKP-E/016-M05	<b>16</b>	M5	5,5	7,0	12,5	5,5	10,5	7,5	7,5	24,0	500	~2,0 kg.	5.000	~20,0 kg.
<b>SKP-E/016-M06/SD</b>		<b>M6</b>	<b>5,5</b>	<b>7,0</b>	<b>12,5</b>	<b>6,5</b>	<b>10,5</b>	<b>7,5</b>	<b>7,5</b>	<b>24,0</b>	<b>500</b>	<b>~2,0 kg.</b>	<b>5.000</b>	<b>~20,0 kg.</b>
SKP-E/025-M05	<b>25</b>	M5	7,0	9,0	17,5	5,5	14,0	8,5	8,5	30,5	300	~2,4 kg.	3.000	~24,0 kg.
SKP-E/025-M06		M6	7,0	9,0	17,5	6,5	14,0	8,5	8,5	30,5	300	~2,4 kg.	3.000	~24,0 kg.
<b>SKP-E/025-M08/SD</b>	<b>M8</b>	<b>7,0</b>	<b>9,0</b>	<b>17,5</b>	<b>8,5</b>	<b>14,0</b>	<b>8,5</b>	<b>8,5</b>	<b>30,5</b>	<b>300</b>	<b>~2,4 kg.</b>	<b>3.000</b>	<b>~24,0 kg.</b>	
SKP-E/035-M06	<b>35</b>	M6	8,5	10,5	18,5	6,5	16,0	9,5	9,5	34,0	200	~2,2 kg.	2.000	~22,0 kg.
<b>SKP-E/035-M08/SD</b>		<b>M8</b>	<b>8,5</b>	<b>10,5</b>	<b>18,5</b>	<b>8,5</b>	<b>16,0</b>	<b>9,5</b>	<b>9,5</b>	<b>34,0</b>	<b>200</b>	<b>~2,2 kg.</b>	<b>2.000</b>	<b>~22,0 kg.</b>
SKP-E/050-M06	<b>50</b>	M6	10,0	12,0	20,0	6,5	18,0	11,0	11,0	39,5	125	~1,8 kg.	1.250	~18,0 kg.
SKP-E/050-M08		M8	10,0	12,0	20,0	8,5	18,0	11,0	11,0	39,5	125	~1,9 kg.	1.250	~19,0 kg.
<b>SKP-E/050-M10/SD</b>		<b>M10</b>	<b>10,0</b>	<b>12,0</b>	<b>20,0</b>	<b>10,5</b>	<b>18,0</b>	<b>11,0</b>	<b>11,0</b>	<b>39,5</b>	<b>125</b>	<b>~1,8 kg.</b>	<b>1.250</b>	<b>~18,0 kg.</b>
SKP-E/070-M06	<b>70</b>	M6	11,5	14,0	22,0	6,5	21,0	11,0	11,0	42,0	80	~1,7 kg.	800	~17,0 kg.
SKP-E/070-M08		M8	11,5	14,0	22,0	8,5	21,0	11,0	11,0	42,0	80	~1,7 kg.	800	~17,0 kg.
<b>SKP-E/070-M10/SD</b>		<b>M10</b>	<b>11,5</b>	<b>14,0</b>	<b>22,0</b>	<b>10,5</b>	<b>21,0</b>	<b>11,0</b>	<b>11,0</b>	<b>42,0</b>	<b>80</b>	<b>~1,7 kg.</b>	<b>800</b>	<b>~17,0 kg.</b>
SKP-E/095-M08	<b>95</b>	M8	13,5	16,0	25,0	8,5	24,5	12,0	12,5	48,0	60	~1,8 kg.	600	~18,0 kg.
SKP-E/095-M10		M10	13,5	16,0	25,0	10,5	24,5	12,0	12,5	48,0	60	~1,9 kg.	600	~19,0 kg.
<b>SKP-E/095-M12/SD</b>		<b>M12</b>	<b>13,5</b>	<b>16,0</b>	<b>25,0</b>	<b>13,0</b>	<b>24,5</b>	<b>12,0</b>	<b>12,5</b>	<b>48,0</b>	<b>60</b>	<b>~1,8 kg.</b>	<b>600</b>	<b>~18,0 kg.</b>
SKP-E/120-M08	<b>120</b>	M8	15,5	18,0	27,0	8,5	27,0	14,0	14,0	52,0	50	~1,8 kg.	500	~18,0 kg.
SKP-E/120-M10		M10	15,5	18,0	27,0	10,5	27,0	14,0	14,0	52,0	50	~1,8 kg.	500	~18,0 kg.
<b>SKP-E/120-M12/SD</b>		<b>M12</b>	<b>15,5</b>	<b>18,0</b>	<b>27,0</b>	<b>13,0</b>	<b>27,0</b>	<b>14,0</b>	<b>14,0</b>	<b>52,0</b>	<b>50</b>	<b>~1,8 kg.</b>	<b>500</b>	<b>~18,0 kg.</b>
SKP-E/150-M08	<b>150</b>	M8	16,5	20,0	29,0	8,5	29,0	14,0	14,0	54,5	35	~2,0 kg.	350	~20,0 kg.
SKP-E/150-M10		M10	16,5	20,0	29,0	10,5	29,0	14,0	14,0	54,5	35	~2,0 kg.	350	~20,0 kg.
<b>SKP-E/150-M12/SD</b>		<b>M12</b>	<b>16,5</b>	<b>20,0</b>	<b>29,0</b>	<b>13,0</b>	<b>29,0</b>	<b>14,0</b>	<b>14,0</b>	<b>54,5</b>	<b>35</b>	<b>~2,0 kg.</b>	<b>350</b>	<b>~20,0 kg.</b>
SKP-E/185-M10	<b>185</b>	M10	18,5	22,0	32,0	10,5	32,0	14,5	14,5	61,5	25	~1,8 kg.	250	~18,0 kg.
<b>SKP-E/185-M12/SD</b>		<b>M12</b>	<b>18,5</b>	<b>22,0</b>	<b>32,0</b>	<b>13,0</b>	<b>32,0</b>	<b>14,5</b>	<b>14,5</b>	<b>61,5</b>	<b>25</b>	<b>~1,8 kg.</b>	<b>250</b>	<b>~18,0 kg.</b>
SKP-E/185-M16		M16	18,5	22,0	32,0	16,5	32,0	14,5	14,5	61,5	25	~1,8 kg.	250	~18,0 kg.
SKP-E/240-M10	<b>240</b>	M10	21,5	25,5	36,5	10,5	37,5	16,0	16,0	69,0	20	~2,2 kg.	200	~22,0 kg.
<b>SKP-E/240-M12/SD</b>		<b>M12</b>	<b>21,5</b>	<b>25,5</b>	<b>36,5</b>	<b>13,0</b>	<b>37,5</b>	<b>16,0</b>	<b>16,0</b>	<b>69,0</b>	<b>20</b>	<b>~2,2 kg.</b>	<b>200</b>	<b>~22,0 kg.</b>
SKP-E/240-M16		M16	21,5	25,5	36,5	16,5	37,5	16,0	16,0	69,0	20	~2,2 kg.	200	~22,0 kg.

### SKP-E SPECIFICATIONS

MATERIAL	ELECTROLYTIC COPPER CONFORMED TO EN 13800
COATING	TIN PLATED
JOINT	CLAMP COUPLING
THICKNESS	MEDIUM
CABLE ENTRY	STANDARD

THE CABLE LUGS WHICH ARE INDICATED IN BOLD FONT, ARE STANDARD PRODUCTS OF **Simpa**



# SKP-A

## VISIBLE TYPE TUBULAR CABLE LUGS

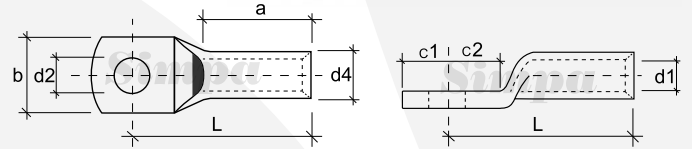

All rights reserved.

Order Code	Cable Section (mm <sup>2</sup> )	Bolt	Dimensions								Box Pcs.	Box Weight	Parcel Pcs.	Box Weight
			d1	d4	a	d2	b	c1	c2	L				
SKP-A/006-M04	6	M4	4,0	5,5	9,5	4,3	9,0	6,5	6,5	18,0	1.000	~2,2 kg.	8.000	~17,6 kg.
SKP-A/006-M05/SD		M5	4,0	5,5	9,5	5,3	9,0	6,5	6,5	18,0	1.000	~2,2 kg.	8.000	~17,6 kg.
SKP-A/010-M04	10	M4	4,5	6,0	11,5	4,3	9,0	7,0	7,0	20,0	800	~2,2 kg.	6.400	~17,6 kg.
SKP-A/010-M05/SD		M5	4,5	6,0	11,5	5,3	9,0	7,0	7,0	20,0	800	~2,2 kg.	6.400	~17,6 kg.
SKP-A/016-M05	16	M5	5,5	7,5	13,0	5,3	11,5	7,5	7,5	23,5	400	~2,1 kg.	3.200	~16,8 kg.
SKP-A/016-M06/SD		M6	5,5	7,5	13,0	6,5	11,5	7,5	7,5	23,5	400	~2,0 kg.	3.200	~16,0 kg.
SKP-A/025-M05	25	M5	7,0	9,5	17,5	5,3	14,0	8,5	8,5	28,5	300	~2,7 kg.	2.400	~21,6 kg.
SKP-A/025-M06		M6	7,0	9,5	17,5	6,5	14,0	8,5	8,5	28,5	300	~2,7 kg.	2.400	~21,6 kg.
SKP-A/025-M08/SD		M8	7,0	9,5	17,5	8,5	14,0	8,5	8,5	28,5	300	~2,7 kg.	2.400	~21,6 kg.
SKP-A/035-M06	35	M6	8,5	11,0	19,5	6,5	16,5	9,5	9,5	33,0	200	~2,6 kg.	1.600	~20,8 kg.
SKP-A/035-M08/SD		M8	8,5	11,0	19,5	8,5	16,5	9,5	9,5	33,0	200	~2,7 kg.	1.600	~21,6 kg.
SKP-A/035-M10		M10	8,5	11,0	19,5	10,5	16,5	10,0	10,0	33,0	200	~2,5 kg.	1.600	~20,0 kg.
SKP-A/050-M06	50	M6	10,0	13,0	21,0	6,5	19,0	11,0	11,0	37,5	125	~2,6 kg.	1.000	~20,8 kg.
SKP-A/050-M08		M8	10,0	13,0	21,0	8,5	19,0	11,0	11,0	37,5	125	~2,8 kg.	1.000	~22,4 kg.
SKP-A/050-M10/SD		M10	10,0	13,0	21,0	10,5	19,0	11,0	11,0	37,5	125	~2,6 kg.	1.000	~20,8 kg.
SKP-A/050-M12		M12	10,0	13,0	21,0	13,0	19,0	11,0	11,0	37,5	125	~2,5 kg.	1.000	~20,0 kg.
SKP-A/070-M06	70	M6	11,5	14,5	24,0	6,5	21,5	11,0	11,0	40,0	80	~2,2 kg.	640	~17,6 kg.
SKP-A/070-M08		M8	11,5	14,5	24,0	8,5	21,5	11,0	11,0	40,0	80	~2,1 kg.	640	~16,8 kg.
SKP-A/070-M10/SD		M10	11,5	14,5	24,0	10,5	21,5	11,0	11,0	40,0	80	~2,1 kg.	640	~16,8 kg.
SKP-A/070-M12		M12	11,5	14,5	24,0	13,0	21,5	11,0	11,0	40,0	80	~1,9 kg.	640	~15,2 kg.
SKP-A/070-M14		M14	11,5	14,5	24,0	14,5	21,5	11,0	11,0	40,0	80	~1,9 kg.	640	~15,2 kg.
SKP-A/095-M08	95	M8	13,5	16,5	27,0	8,5	24,0	12,0	12,5	45,5	60	~2,0 kg.	480	~16,0 kg.
SKP-A/095-M10		M10	13,5	16,5	27,0	10,5	24,0	12,0	12,5	45,5	60	~2,0 kg.	480	~16,0 kg.
SKP-A/095-M12/SD		M12	13,5	16,5	27,0	13,0	24,0	12,0	12,5	45,5	60	~1,9 kg.	480	~15,2 kg.
SKP-A/120-M08	120	M8	14,5	18,0	30,0	8,5	26,5	14,0	14,0	50,5	50	~2,4 kg.	400	~19,2 kg.
SKP-A/120-M10		M10	14,5	18,0	30,0	10,5	26,5	14,0	14,0	50,5	50	~2,4 kg.	400	~19,2 kg.
SKP-A/120-M12/SD		M12	14,5	18,0	30,0	13,0	26,5	14,0	14,0	50,5	50	~2,4 kg.	400	~19,2 kg.
SKP-A/120-M14		M14	14,5	18,0	30,0	14,5	26,5	14,0	14,0	50,5	50	~2,3 kg.	400	~18,4 kg.
SKP-A/120-M16		M16	14,5	18,0	30,0	16,5	26,5	14,0	14,0	50,5	50	~2,3 kg.	400	~18,4 kg.
SKP-A/150-M08	150	M8	16,5	21,0	31,5	8,5	30,5	14,0	14,0	54,5	30	~2,4 kg.	240	~19,2 kg.
SKP-A/150-M10		M10	16,5	21,0	31,5	10,5	30,5	14,0	14,0	54,5	30	~2,4 kg.	240	~19,2 kg.
SKP-A/150-M12/SD		M12	16,5	21,0	31,5	13,0	30,5	15,0	15,0	54,5	30	~2,3 kg.	240	~18,4 kg.
SKP-A/150-M14		M14	16,5	21,0	31,5	14,5	30,5	15,0	15,0	54,5	30	~2,3 kg.	240	~18,4 kg.
SKP-A/150-M16		M16	16,5	21,0	31,5	16,5	30,5	15,0	15,0	54,5	30	~2,2 kg.	240	~17,6 kg.
SKP-A/150-M20		M20	16,5	21,0	31,5	21,0	30,5	15,0	15,0	54,5	30	~2,1 kg.	240	~16,8 kg.
SKP-A/185-M10	185	M10	18,5	23,0	34,5	10,5	33,5	16,0	16,0	61,0	20	~1,9 kg.	160	~15,2 kg.
SKP-A/185-M12/SD		M12	18,5	23,0	34,5	13,0	33,5	16,0	16,0	61,0	20	~1,9 kg.	160	~15,2 kg.
SKP-A/185-M14		M14	18,5	23,0	34,5	14,5	33,5	16,0	16,0	61,0	20	~1,8 kg.	160	~14,4 kg.
SKP-A/185-M16		M16	18,5	23,0	34,5	16,5	33,5	16,0	16,0	61,0	20	~1,8 kg.	160	~14,4 kg.
SKP-A/185-M20	M20	18,5	23,0	34,5	21,0	33,5	16,0	16,0	61,0	20	~1,7 kg.	160	~13,6 kg.	

Order Code	Cable Section (mm <sup>2</sup> )	Bolt	Dimensions								Box Pcs.	Box Weight	Parcel Pcs.	Box Weight
			d1	d4	a	d2	b	c1	c2	L				
SKP-A/240-M10	<b>240</b>	M10	21,0	26,0	39,0	10,5	38,0	16,5	16,5	65,5	20	~2,5 kg.	160	~20,0 kg.
<b>SKP-A/240-M12/SD</b>		<b>M12</b>	<b>21,0</b>	<b>26,0</b>	<b>39,0</b>	<b>13,0</b>	<b>38,0</b>	<b>16,5</b>	<b>16,5</b>	<b>65,5</b>	<b>20</b>	<b>~2,5 kg.</b>	<b>160</b>	<b>~20,0 kg.</b>
SKP-A/240-M14		M14	21,0	26,0	39,0	14,5	38,0	16,5	16,5	65,5	20	~2,5 kg.	160	~20,0 kg.
SKP-A/240-M16		M16	21,0	26,0	39,0	16,5	38,0	16,5	16,5	65,5	20	~2,4 kg.	160	~19,2 kg.
SKP-A/240-M20		M20	21,0	26,0	39,0	21,0	38,0	16,5	16,5	65,5	20	~2,4 kg.	160	~19,2 kg.
SKP-A/300-M12	<b>300</b>	M12	23,5	28,5	42,5	13,0	42,0	19,0	22,0	77,0	16	~2,8 kg.	128	~22,4 kg.
SKP-A/300-M14		M14	23,5	28,5	42,5	15,0	42,0	19,0	22,0	77,0	16	~2,8 kg.	128	~22,4 kg.
<b>SKP-A/300-M16/SD</b>		<b>M16</b>	<b>23,5</b>	<b>28,5</b>	<b>42,5</b>	<b>17,0</b>	<b>42,0</b>	<b>19,0</b>	<b>22,0</b>	<b>77,0</b>	<b>16</b>	<b>~2,8 kg.</b>	<b>128</b>	<b>~22,4 kg.</b>
SKP-A/300-M20		M20	23,5	28,5	42,5	21,0	42,0	19,0	22,0	77,0	16	~2,7 kg.	128	~21,6 kg.
SKP-A/400-M12	<b>400</b>	M12	27,0	33,0	47,0	13,0	48,0	20,0	20,0	84,0	6		48	
SKP-A/400-M14		M14	27,0	33,0	47,0	15,0	48,0	20,0	20,0	84,0	6		48	
<b>SKP-A/400-M16/SD</b>		<b>M16</b>	<b>27,0</b>	<b>33,0</b>	<b>47,0</b>	<b>17,0</b>	<b>48,0</b>	<b>20,0</b>	<b>20,0</b>	<b>84,0</b>	<b>6</b>		<b>48</b>	
SKP-A/400-M20		M20	27,0	33,0	47,0	21,0	48,0	20,0	20,0	84,0	6		48	

**SKP-A SPECIFICATIONS**

MATERIAL	ELECTROLYTIC COPPER CONFORMED TO EN 13600
COATING	TIN PLATED
JOINT	CLAMP COUPLING OR SOLDER
THICKNESS	THICK
CABLE ENTRY	STANDARD

THE CABLE LUGS WHICH ARE INDICATED IN BOLD FONT, ARE STANDARD PRODUCTS OF **Simpa**



# SKP-S

## STANDARD TYPE TUBULAR CABLE LUGS

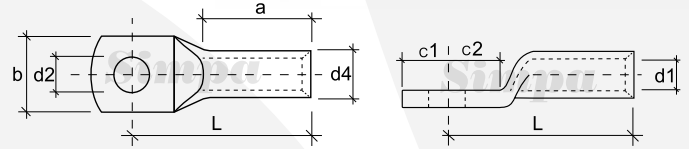

All rights reserved.

Order Code	Cable Section (mm <sup>2</sup> )	Bolt	Dimensions								Box Pcs.	Box Weight	Parcel Pcs.	Box Weight
			d1	d4	a	d2	b	c1	c2	L				
SKP-S/006-M04	6	M4	4,0	5,5	9,5	4,3	9,0	6,5	6,5	19,0	1.000	~2,3 kg.	8.000	~18,4 kg.
<b>SKP-S/006-M05/SD</b>		<b>M5</b>	<b>4,0</b>	<b>5,5</b>	<b>9,5</b>	<b>5,3</b>	<b>9,0</b>	<b>6,5</b>	<b>6,5</b>	<b>19,0</b>	<b>1.000</b>	<b>~2,2 kg.</b>	<b>8.000</b>	<b>~17,6 kg.</b>
SKP-S/006-M06		M6	4,0	6,0	11,0	6,4	11,0	7,0	7,0	21,0	700	~2,4 kg.	5.600	~20,0 kg.
SKP-S/006-M08		M8	4,0	6,0	11,0	8,4	13,5	8,0	8,0	22,5	600	~2,2 kg.	4.800	~17,6 kg.
SKP-S/010-M04	10	M4	4,5	6,0	10,5	4,3	9,0	7,0	7,0	21,0	800	~2,3 kg.	6.400	~18,4 kg.
<b>SKP-S/010-M05/SD</b>		<b>M5</b>	<b>4,5</b>	<b>6,0</b>	<b>10,5</b>	<b>5,3</b>	<b>10,0</b>	<b>7,0</b>	<b>7,0</b>	<b>21,0</b>	<b>800</b>	<b>~2,3 kg.</b>	<b>6.400</b>	<b>~18,4 kg.</b>
SKP-S/010-M06		M6	4,5	6,5	12,0	6,4	11,0	7,0	7,0	23,0	700	~2,9 kg.	5.600	~23,2 kg.
SKP-S/010-M08		M8	4,5	6,5	12,0	8,4	14,0	8,0	8,0	24,5	600	~2,5 kg.	4.800	~20,0 kg.
SKP-S/010-M10	M10	4,5	6,5	12,0	10,5	16,0	9,0	9,0	28,0	500	~2,2 kg.	4.000	~17,6 kg.	
SKP-S/016-M05	16	M5	5,5	7,5	12,5	5,3	12,0	7,5	7,5	24,0	400	~2,2 kg.	3.200	~17,6 kg.
<b>SKP-S/016-M06/SD</b>		<b>M6</b>	<b>5,5</b>	<b>7,5</b>	<b>12,5</b>	<b>6,5</b>	<b>12,0</b>	<b>7,5</b>	<b>7,5</b>	<b>24,0</b>	<b>400</b>	<b>~2,1 kg.</b>	<b>3.200</b>	<b>~16,8 kg.</b>
SKP-S/016-M08		M8	5,5	7,5	13,0	8,4	13,5	8,0	8,0	25,5	500	~2,6 kg.	4.000	~20,8 kg.
SKP-S/016-M10		M10	5,5	7,5	13,0	10,5	16,0	9,0	9,0	27,0	400	~2,2 kg.	3.200	~17,6 kg.
SKP-S/025-M06	25	M6	7,0	9,5	17,5	6,5	14,0	8,5	8,5	30,5	300	~2,8 kg.	2.400	~22,4 kg.
<b>SKP-S/025-M08/SD</b>		<b>M8</b>	<b>7,0</b>	<b>9,5</b>	<b>17,5</b>	<b>8,5</b>	<b>14,0</b>	<b>8,5</b>	<b>8,5</b>	<b>30,5</b>	<b>300</b>	<b>~3,0 kg.</b>	<b>2.400</b>	<b>~24,0 kg.</b>
SKP-S/025-M10		M10	7,0	9,5	17,5	10,5	16,0	10,0	10,0	31,5	250	~2,4 kg.	2.000	~19,2 kg.
SKP-S/025-M12		M12	7,0	9,5	17,5	13,0	18,0	11,0	11,0	35,0	200	~2,2 kg.	1.600	~17,6 kg.
SKP-S/035-M06	35	M6	8,5	11,0	19,0	6,5	16,5	9,5	9,5	34,5	200	~2,9 kg.	1.600	~23,2 kg.
<b>SKP-S/035-M08/SD</b>		<b>M8</b>	<b>8,5</b>	<b>11,0</b>	<b>19,0</b>	<b>8,5</b>	<b>16,5</b>	<b>9,5</b>	<b>9,5</b>	<b>34,5</b>	<b>200</b>	<b>~2,7 kg.</b>	<b>1.600</b>	<b>~21,6 kg.</b>
SKP-S/035-M10		M10	8,5	11,0	19,0	10,5	17,0	10,0	10,0	34,5	200	~2,6 kg.	1.600	~20,8 kg.
SKP-S/035-M12		M12	8,5	11,0	19,0	13,0	18,5	11,0	11,0	36,5	150	~2,1 kg.	1.200	~16,8 kg.
SKP-S/050-M06	50	M6	10,0	13,0	20,0	6,5	19,0	11,0	11,0	39,5	125	~2,9 kg.	1.000	~23,2 kg.
SKP-S/050-M08		M8	10,0	13,0	20,0	8,5	19,0	11,0	11,0	39,5	125	~2,9 kg.	1.000	~23,2 kg.
<b>SKP-S/050-M10/SD</b>		<b>M10</b>	<b>10,0</b>	<b>13,0</b>	<b>20,0</b>	<b>10,5</b>	<b>19,0</b>	<b>11,0</b>	<b>11,0</b>	<b>39,5</b>	<b>125</b>	<b>~2,8 kg.</b>	<b>1.000</b>	<b>~22,4 kg.</b>
SKP-S/050-M12		M12	10,0	13,0	20,0	13,0	19,0	11,0	11,0	39,5	125	~2,6 kg.	1.000	~20,8 kg.
SKP-S/050-M14	M14	10,0	13,0	20,0	14,5	21,0	13,0	13,0	42,0	100	~2,3 kg.	800	~18,4 kg.	
SKP-S/070-M06	70	M6	11,5	14,5	21,5	6,5	21,5	11,0	11,0	41,5	80	~2,3 kg.	640	~18,4 kg.
SKP-S/070-M08		M8	11,5	14,5	21,5	8,5	21,5	11,0	11,0	41,5	80	~2,1 kg.	640	~16,8 kg.
<b>SKP-S/070-M10/SD</b>		<b>M10</b>	<b>11,5</b>	<b>14,5</b>	<b>21,5</b>	<b>10,5</b>	<b>21,5</b>	<b>11,0</b>	<b>11,0</b>	<b>41,5</b>	<b>80</b>	<b>~2,1 kg.</b>	<b>640</b>	<b>~16,8 kg.</b>
SKP-S/070-M12		M12	11,5	14,5	21,5	13,0	21,5	11,0	11,0	41,5	80	~2,1 kg.	640	~16,8 kg.
SKP-S/070-M14	M14	11,5	14,5	21,5	14,5	23,0	13,0	13,0	44,0	70	~2,0 kg.	560	~16,0 kg.	
SKP-S/070-M16	M16	11,5	14,5	21,5	16,5	23,0	16,0	16,0	46,5	70	~2,0 kg.	560	~16,0 kg.	
SKP-S/095-M06	95	M6	13,5	16,5	25,0	6,5	24,0	12,0	12,5	48,0	60	~2,2 kg.	480	~17,6 kg.
SKP-S/095-M08		M8	13,5	16,5	25,0	8,5	24,0	12,0	12,5	48,0	60	~2,2 kg.	480	~17,6 kg.
SKP-S/095-M10		M10	13,5	16,5	25,0	10,5	24,0	12,0	12,5	48,0	60	~2,2 kg.	480	~17,6 kg.
<b>SKP-S/095-M12/SD</b>		<b>M12</b>	<b>13,5</b>	<b>16,5</b>	<b>25,0</b>	<b>13,0</b>	<b>24,0</b>	<b>12,0</b>	<b>12,5</b>	<b>48,0</b>	<b>60</b>	<b>~2,1 kg.</b>	<b>480</b>	<b>~16,8 kg.</b>
SKP-S/095-M14		M14	13,5	16,5	25,0	14,5	26,0	14,0	14,0	50,0	50	~1,9 kg.	400	~15,2 kg.
SKP-S/095-M16		M16	13,5	16,5	25,0	16,5	26,0	16,0	16,0	52,0	50	~1,9 kg.	400	~15,2 kg.

Order Code	Cable Section (mm <sup>2</sup> )	Bolt	Dimensions								Box Pcs.	Box Weight	Parcel Pcs.	Box Weight
			d1	d4	a	d2	b	c1	c2	L				
SKP-S/120-M08	<b>120</b>	M8	14,5	18,0	27,0	8,5	26,5	14,0	14,0	52,0	50	~2,4 kg.	400	~19,2 kg.
SKP-S/120-M10		M10	14,5	18,0	27,0	10,5	26,5	14,0	14,0	52,0	50	~2,4 kg.	400	~19,2 kg.
<b>SKP-S/120-M12/SD</b>		<b>M12</b>	<b>14,5</b>	<b>18,0</b>	<b>27,0</b>	<b>13,0</b>	<b>26,5</b>	<b>14,0</b>	<b>14,0</b>	<b>52,0</b>	<b>50</b>	<b>~2,4 kg.</b>	<b>400</b>	<b>~19,2 kg.</b>
SKP-S/120-M14		M14	14,5	18,0	27,0	14,5	26,5	14,0	14,0	52,0	50	~1,8 kg.	400	~14,4 kg.
SKP-S/120-M16		M16	14,5	18,0	27,0	16,5	26,5	14,0	14,0	52,0	50	~1,8 kg.	400	~14,4 kg.
SKP-S/120-M20		M20	14,5	18,0	27,0	21,0	29,0	16,0	16,0	54,0	40	~1,9 kg.	320	~15,2 kg.
SKP-S/150-M06	<b>150</b>	M6	16,5	21,0	29,0	6,5	30,5	14,0	14,0	57,0	30	~2,5 kg.	240	~20,0 kg.
SKP-S/150-M08		M8	16,5	21,0	29,0	8,5	30,5	14,0	14,0	57,0	30	~2,5 kg.	240	~20,0 kg.
SKP-S/150-M10		M10	16,5	21,0	29,0	10,5	30,5	14,0	14,0	57,0	30	~2,5 kg.	240	~20,0 kg.
<b>SKP-S/150-M12/SD</b>		<b>M12</b>	<b>16,5</b>	<b>21,0</b>	<b>29,0</b>	<b>13,0</b>	<b>30,5</b>	<b>15,0</b>	<b>15,0</b>	<b>57,0</b>	<b>30</b>	<b>~2,5 kg.</b>	<b>240</b>	<b>~20,0 kg.</b>
SKP-S/150-M14		M14	16,5	21,0	29,0	14,5	30,5	15,0	15,0	57,0	30	~2,3 kg.	240	~18,4 kg.
SKP-S/150-M16		M16	16,5	21,0	29,0	16,5	30,5	15,0	15,0	57,0	30	~2,3 kg.	240	~18,4 kg.
SKP-S/150-M20	M20	16,5	21,0	29,0	21,0	30,5	15,0	15,0	57,0	30	~2,2 kg.	240	~17,6 kg.	
SKP-S/185-M10	<b>185</b>	M10	18,5	23,0	33,0	10,5	33,5	16,0	16,0	63,0	20	~2,0 kg.	160	~16,0 kg.
<b>SKP-S/185-M12/SD</b>		<b>M12</b>	<b>18,5</b>	<b>23,0</b>	<b>33,0</b>	<b>13,0</b>	<b>33,5</b>	<b>16,0</b>	<b>16,0</b>	<b>63,0</b>	<b>20</b>	<b>~2,0 kg.</b>	<b>160</b>	<b>~16,0 kg.</b>
SKP-S/185-M14		M14	18,5	23,0	33,0	14,5	33,5	16,0	16,0	63,0	20	~1,9 kg.	160	~15,2 kg.
SKP-S/185-M16		M16	18,5	23,0	33,0	16,5	33,5	16,0	16,0	63,0	20	~1,9 kg.	160	~15,2 kg.
SKP-S/185-M20	M20	18,5	23,0	33,0	21,0	33,5	16,0	16,0	63,0	20	~1,8 kg.	160	~14,4 kg.	
SKP-S/240-M10	<b>240</b>	M10	21,0	26,0	37,0	10,5	38,0	16,5	16,5	70,0	20	~2,8 kg.	160	~22,4 kg.
<b>SKP-S/240-M12/SD</b>		<b>M12</b>	<b>21,0</b>	<b>26,0</b>	<b>37,0</b>	<b>13,0</b>	<b>38,0</b>	<b>16,5</b>	<b>16,5</b>	<b>70,0</b>	<b>20</b>	<b>~2,7 kg.</b>	<b>160</b>	<b>~21,6 kg.</b>
SKP-S/240-M14		M14	21,0	26,0	37,0	14,5	38,0	16,5	16,5	70,0	20	~2,6 kg.	160	~20,8 kg.
SKP-S/240-M16		M16	21,0	26,0	37,0	16,5	38,0	16,5	16,5	70,0	20	~2,6 kg.	160	~20,8 kg.
SKP-S/240-M20	M20	21,0	26,0	37,0	21,0	38,0	16,5	16,5	70,0	20	~2,5 kg.	160	~20,0 kg.	
SKP-S/300-M10	<b>300</b>	M10	23,5	28,5	41,0	10,5	42,0	19,0	22,0	80,0	16	~2,8 kg.	128	~22,4 kg.
SKP-S/300-M12		M12	23,5	28,5	41,0	13,0	42,0	19,0	22,0	80,0	16	~2,8 kg.	128	~22,4 kg.
SKP-S/300-M14		M14	23,5	28,5	41,0	15,0	42,0	19,0	22,0	80,0	16	~2,7 kg.	128	~21,6 kg.
<b>SKP-S/300-M16/SD</b>		<b>M16</b>	<b>23,5</b>	<b>28,5</b>	<b>41,0</b>	<b>17,0</b>	<b>42,0</b>	<b>19,0</b>	<b>22,0</b>	<b>80,0</b>	<b>16</b>	<b>~2,6 kg.</b>	<b>128</b>	<b>~20,8 kg.</b>
SKP-S/300-M20		M20	23,5	28,5	41,0	21,0	42,0	19,0	22,0	80,0	16	~2,5 kg.	128	~20,0 kg.
SKP-S/400-M12	<b>400</b>	M12	27,0	33,0	46,0	13,0	48,0	20,0	20,0	90,0	6	~1,7 kg.	48	~13,6 kg.
SKP-S/400-M14		M14	27,0	33,0	46,0	15,0	48,0	20,0	20,0	90,0	6	~1,7 kg.	48	~13,6 kg.
<b>SKP-S/400-M16/SD</b>		<b>M16</b>	<b>27,0</b>	<b>33,0</b>	<b>46,0</b>	<b>17,0</b>	<b>48,0</b>	<b>20,0</b>	<b>20,0</b>	<b>90,0</b>	<b>6</b>	<b>~1,6 kg.</b>	<b>48</b>	<b>~12,8 kg.</b>
SKP-S/400-M20	M20	27,0	33,0	46,0	21,0	48,0	20,0	20,0	90,0	6	~1,7 kg.	48	~13,6 kg.	
SKP-S/500-M16	<b>500</b>	M16	30,0	38,0	56,0	17,0	55,0	22,0	22,0	100,0	5	~2,2 kg.	40	~17,6 kg.
<b>SKP-S/500-M20/SD</b>		<b>M20</b>	<b>30,0</b>	<b>38,0</b>	<b>56,0</b>	<b>21,0</b>	<b>55,0</b>	<b>22,0</b>	<b>22,0</b>	<b>100,0</b>	<b>5</b>	<b>~2,1 kg.</b>	<b>40</b>	<b>~16,8 kg.</b>
SKP-S/625-M16	<b>625</b>	M16	34,0	42,0	60,0	17,0	61,0	23,0	23,0	113,0	4	~2,3 kg.	32	~18,4 kg.
<b>SKP-S/625-M20/SD</b>		<b>M20</b>	<b>34,0</b>	<b>42,0</b>	<b>60,0</b>	<b>21,0</b>	<b>61,0</b>	<b>23,0</b>	<b>23,0</b>	<b>113,0</b>	<b>4</b>	<b>~2,3 kg.</b>	<b>32</b>	<b>~18,4 kg.</b>

**SKP-S SPECIFICATIONS**

MATERIAL	ELECTROLYTIC COPPER CONFORMED TO EN 13600
COATING	TIN PLATED
JOINT	CLAMP COUPLING
THICKNESS	THICK
CABLE ENTRY	STANDARD

THE CABLE LUGS WHICH ARE INDICATED IN BOLD FONT, ARE STANDARD PRODUCTS OF **Simpa**



# SKP-S1

## EUROPE TYPE TUBULAR CABLE LUGS

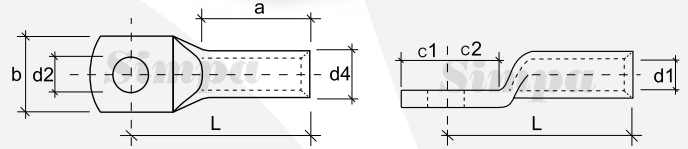

All rights reserved.

Order Code	Cable Section (mm <sup>2</sup> )	Bolt	Dimensions								Box Pcs.	Box Weight	Parcel Pcs.	Box Weight
			d1	d4	a	d2	b	c1	c2	L				
SKP-S1/002,5-M04	2.5	M4	2,3	4,2	6,0	4,3	7,5	4,0	5,0	13,0	1.000	~1,2 kg.	6.000	~7,2 kg.
<b>SKP-S1/002,5-M05/SD</b>		<b>M5</b>	<b>2,3</b>	<b>4,2</b>	<b>6,0</b>	<b>5,3</b>	<b>8,5</b>	<b>4,75</b>	<b>5,5</b>	<b>14,0</b>	<b>1.000</b>	<b>~1,3 kg.</b>	<b>6.000</b>	<b>~7,8 kg.</b>
SKP-S1/002,5-M06		M6	2,3	4,2	6,0	6,5	9,5	6,5	6,5	16,0	1.000	~1,5 kg.	6.000	~9,0 kg.
<b>SKP-S1/004-M05/SD</b>	4	<b>M5</b>	<b>3,0</b>	<b>5,0</b>	<b>8,0</b>	<b>5,3</b>	<b>9,0</b>	<b>4,75</b>	<b>6,0</b>	<b>18,0</b>	<b>700</b>	<b>~1,6 kg.</b>	<b>4.200</b>	<b>~9,6 kg.</b>
SKP-S1/004-M06		M6	3,0	5,0	8,0	6,5	10,0	6,5	6,5	19,0	700	~1,8 kg.	4.200	~10,8 kg.
SKP-S1/004-M08		M8	3,0	5,0	8,0	8,5	13,0	8,5	9,5	22,0	700	~2,2 kg.	4.200	~15,4 kg.
<b>SKP-S1/006-M06/SD</b>	6	<b>M6</b>	<b>3,5</b>	<b>6,5</b>	<b>9,0</b>	<b>6,5</b>	<b>12,0</b>	<b>6,5</b>	<b>7,5</b>	<b>21,0</b>	<b>500</b>	<b>~2,4 kg.</b>	<b>3.000</b>	<b>~14,4 kg.</b>
SKP-S1/006-M08		M8	3,5	6,5	9,0	8,5	15,0	10,0	10,0	23,0	500	~2,8 kg.	3.000	~16,8 kg.
SKP-S1/006-M10		M10	3,5	6,5	9,0	10,5	17,0	12,0	12,0	25,0	500	~3,0 kg.	3.000	~18,0 kg.
SKP-S1/006-M12		M12	3,5	6,5	9,0	13,0	19,0	13,0	13,0	28,0	400	~2,8 kg.	3.000	~16,8 kg.
SKP-S1/010-M05	10	M5	4,5	7,0	10,0	5,5	12,0	6,5	7,5	22,0	500	~2,1 kg.	3.000	~12,6 kg.
<b>SKP-S1/010-M06/SD</b>		<b>M6</b>	<b>4,5</b>	<b>7,0</b>	<b>10,0</b>	<b>6,5</b>	<b>12,0</b>	<b>6,2</b>	<b>7,5</b>	<b>22,0</b>	<b>500</b>	<b>~2,1 kg.</b>	<b>3.000</b>	<b>~12,6 kg.</b>
SKP-S1/010-M08		M8	4,5	7,5	10,0	8,5	15,0	10,0	10,0	25,0	400	~2,4 kg.	2.400	~14,4 kg.
SKP-S1/010-M10		M10	4,5	7,5	10,0	10,5	17,0	12,0	12,0	27,0	400	~2,6 kg.	2.400	~15,6 kg.
SKP-S1/010-M12		M12	4,5	7,5	10,0	13,0	19,0	13,0	13,0	29,0	300	~2,0 kg.	1.800	~12,0 kg.
SKP-S1/016-M05	16	M5	5,5	8,5	13,0	5,5	12,0	5,5	6,5	26,0	400	~2,2 kg.	2.400	~13,2 kg.
SKP-S1/016-M06		M6	5,5	8,5	13,0	6,5	12,0	6,2	7,5	27,0	400	~3,4 kg.	2.400	~20,4 kg.
<b>SKP-S1/016-M08/SD</b>		<b>M8</b>	<b>5,5</b>	<b>8,5</b>	<b>13,0</b>	<b>8,4</b>	<b>15,0</b>	<b>8,5</b>	<b>9,5</b>	<b>29,0</b>	<b>300</b>	<b>~2,8 kg.</b>	<b>1.800</b>	<b>~16,8 kg.</b>
SKP-S1/016-M10		M10	5,5	8,5	13,0	10,5	17,0	10,5	11,5	31,0	300	~3,0 kg.	1.800	~18,0 kg.
SKP-S1/016-M12		M12	5,5	8,5	13,0	13,0	19,0	13,0	13,0	33,0	250	~2,6 kg.	1.500	~15,6 kg.
SKP-S1/025-M05	25	M5	7,0	10,0	15,0	5,5	14,0	7,5	7,5	30,0	200	~2,5 kg.	1.200	~15,0 kg.
SKP-S1/025-M06		M6	7,0	10,0	15,0	6,5	14,0	7,5	7,5	30,0	200	~2,4 kg.	1.200	~14,4 kg.
<b>SKP-S1/025-M08/SD</b>		<b>M8</b>	<b>7,0</b>	<b>10,0</b>	<b>15,0</b>	<b>8,4</b>	<b>16,0</b>	<b>10,0</b>	<b>10,0</b>	<b>32,0</b>	<b>200</b>	<b>~2,7 kg.</b>	<b>1.200</b>	<b>~16,2 kg.</b>
SKP-S1/025-M10		M10	7,0	10,0	15,0	10,5	18,0	12,0	12,0	34,0	200	~2,8 kg.	1.200	~16,8 kg.
SKP-S1/025-M12		M12	7,0	10,0	15,0	13,0	19,0	13,0	13,0	35,0	200	~2,8 kg.	1.200	~16,8 kg.
SKP-S1/035-M06	35	M6	8,5	12,0	17,0	6,5	17,0	7,5	7,5	32,0	125	~2,3 kg.	750	~13,8 kg.
<b>SKP-S1/035-M08/SD</b>		<b>M8</b>	<b>8,5</b>	<b>12,0</b>	<b>17,0</b>	<b>8,4</b>	<b>17,0</b>	<b>10,0</b>	<b>10,0</b>	<b>34,0</b>	<b>125</b>	<b>~2,5 kg.</b>	<b>750</b>	<b>~15,0 kg.</b>
SKP-S1/035-M10		M10	8,5	12,0	17,0	10,5	19,0	12,0	12,0	37,0	125	~2,7 kg.	750	~16,2 kg.
SKP-S1/035-M12		M12	8,5	12,0	17,0	13,0	21,0	13,0	13,0	38,0	125	~2,7 kg.	750	~16,2 kg.
SKP-S1/035-M16		M16	8,5	12,0	17,0	17,0	26,0	16,0	16,0	42,0	100	~2,9 kg.	600	~17,4 kg.
SKP-S1/050-M06	50	M6	10,0	14,0	19,0	6,5	20,0	10,0	10,0	37,0	80	~2,4 kg.	480	~14,4 kg.
SKP-S1/050-M08		M8	10,0	14,0	19,0	8,5	20,0	10,0	10,0	37,0	80	~2,3 kg.	480	~13,8 kg.
<b>SKP-S1/050-M10/SD</b>		<b>M10</b>	<b>10,0</b>	<b>14,0</b>	<b>19,0</b>	<b>10,5</b>	<b>20,0</b>	<b>12,0</b>	<b>12,0</b>	<b>39,0</b>	<b>80</b>	<b>~2,5 kg.</b>	<b>480</b>	<b>~15,0 kg.</b>
SKP-S1/050-M12		M12	10,0	14,0	19,0	13,0	23,0	13,0	13,0	43,0	80	~2,7 kg.	480	~16,2 kg.
SKP-S1/050-M14		M14	10,0	14,0	19,0	15,0	23,0	14,5	14,5	45,0	80	~2,7 kg.	480	~16,2 kg.
SKP-S1/050-M16		M16	10,0	14,0	19,0	17,0	28,0	16,0	16,0	46,0	80	~2,8 kg.	480	~16,8 kg.
SKP-S1/050-M20		M20	10,0	14,0	19,0	21,0	30,0	19,0	19,0	48,0	80	~2,7 kg.	480	~16,2 kg.

Order Code	Cable Section (mm <sup>2</sup> )	Bolt	Dimensions								Box Pcs.	Box Weight	Parcel Pcs.	Box Weight	
			d1	d4	a	d2	b	c1	c2	L					
SKP-S1/070-M06	70	M6	12,0	16,5	21,0	6,5	23,0	10,0	10,0	43,0	60	~2,8 kg.	360	~16,8 kg.	
SKP-S1/070-M08		M8	12,0	16,5	21,0	8,5	23,0	10,0	10,0	43,0	60	~2,7 kg.	360	~16,2 kg.	
<b>SKP-S1/070-M10/SD</b>		<b>M10</b>	<b>12,0</b>	<b>16,5</b>	<b>21,0</b>	<b>10,5</b>	<b>23,0</b>	<b>12,0</b>	<b>12,0</b>	<b>44,0</b>	<b>60</b>	<b>~2,8 kg.</b>	<b>360</b>	<b>~16,8 kg.</b>	
SKP-S1/070-M12		M12	12,0	16,5	21,0	13,0	23,0	13,0	13,0	46,0	60	~2,9 kg.	360	~17,4 kg.	
SKP-S1/070-M14		M14	12,0	16,5	21,0	15,0	23,0	14,5	14,5	48,0	60	~2,9 kg.	360	~17,4 kg.	
SKP-S1/070-M16		M16	12,0	16,5	21,0	17,0	28,0	16,0	16,0	50,0	50	~2,6 kg.	300	~15,6 kg.	
SKP-S1/070-M20		M20	12,0	16,5	21,0	21,0	30,0	19,0	19,0	53,0	50	~2,6 kg.	300	~15,6 kg.	
SKP-S1/095-M08	95	M8	13,5	18,0	25,0	8,5	26,0	12,0	12,0	48,0	50	~2,9 kg.	300	~17,4 kg.	
SKP-S1/095-M10		M10	13,5	18,0	25,0	10,5	26,0	12,0	12,0	48,0	50	~2,9 kg.	300	~17,4 kg.	
<b>SKP-S1/095-M12/SD</b>		<b>M12</b>	<b>13,5</b>	<b>18,0</b>	<b>25,0</b>	<b>13,0</b>	<b>26,0</b>	<b>13,0</b>	<b>13,0</b>	<b>49,0</b>	<b>50</b>	<b>~2,8 kg.</b>	<b>300</b>	<b>~16,8 kg.</b>	
SKP-S1/095-M14		M14	13,5	18,0	25,0	15,0	26,0	14,5	14,5	51,0	50	~2,9 kg.	300	~17,4 kg.	
SKP-S1/095-M16		M16	13,5	18,0	25,0	17,0	28,0	16,0	16,0	54,0	50	~3,0 kg.	300	~18,0 kg.	
SKP-S1/095-M20		M20	13,5	18,0	25,0	21,0	36,0	22,0	22,0	60,0	40	~2,8 kg.	240	~16,8 kg.	
SKP-S1/120-M08		120	M8	15,0	19,5	26,0	8,5	28,0	14,0	14,0	51,0	40	~2,7 kg.	240	~16,2 kg.
SKP-S1/120-M10	M10		15,0	19,5	26,0	10,5	28,0	14,0	14,0	51,0	40	~2,7 kg.	240	~16,2 kg.	
<b>SKP-S1/120-M12/SD</b>	<b>M12</b>		<b>15,0</b>	<b>19,5</b>	<b>26,0</b>	<b>13,0</b>	<b>28,0</b>	<b>14,0</b>	<b>14,0</b>	<b>51,0</b>	<b>40</b>	<b>~2,6 kg.</b>	<b>240</b>	<b>~15,6 kg.</b>	
SKP-S1/120-M14	M14		15,0	19,5	26,0	15,0	28,0	15,0	15,0	52,0	40	~2,6 kg.	240	~15,6 kg.	
SKP-S1/120-M16	M16		15,0	19,5	26,0	17,0	30,0	16,0	16,0	54,0	40	~2,7 kg.	240	~16,2 kg.	
SKP-S1/120-M20	M20		15,0	19,5	26,0	21,0	36,0	22,0	22,0	63,0	30	~2,4 kg.	180	~14,4 kg.	
SKP-S1/150-M08	150		M8	16,5	21,0	30,0	8,5	31,0	14,0	14,0	56,0	30	~2,4 kg.	180	~14,4 kg.
SKP-S1/150-M10		M10	16,5	21,0	30,0	10,5	31,0	14,0	14,0	56,0	30	~2,4 kg.	180	~14,4 kg.	
<b>SKP-S1/150-M12/SD</b>		<b>M12</b>	<b>16,5</b>	<b>21,0</b>	<b>30,0</b>	<b>13,0</b>	<b>31,0</b>	<b>15,0</b>	<b>15,0</b>	<b>57,0</b>	<b>30</b>	<b>~2,4 kg.</b>	<b>180</b>	<b>~14,4 kg.</b>	
SKP-S1/150-M14		M14	16,5	21,0	30,0	15,0	31,0	15,0	15,0	57,0	30	~2,4 kg.	180	~14,4 kg.	
SKP-S1/150-M16		M16	16,5	21,0	30,0	17,0	31,0	16,0	16,0	58,0	30	~2,3 kg.	180	~13,8 kg.	
SKP-S1/150-M20		M20	16,5	21,0	30,0	21,0	36,0	22,0	22,0	66,0	30	~2,7 kg.	180	~16,2 kg.	
SKP-S1/185-M10		185	M10	19,0	24,0	30,0	10,5	35,0	18,0	18,0	65,0	20	~2,5 kg.	120	~15,0 kg.
SKP-S1/185-M12	M12		19,0	24,0	30,0	13,0	35,0	18,0	18,0	65,0	20	~2,4 kg.	120	~14,4 kg.	
SKP-S1/185-M14	M14		19,0	24,0	30,0	15,0	35,0	18,0	18,0	65,0	20	~2,3 kg.	120	~13,8 kg.	
<b>SKP-S1/185-M16/SD</b>	<b>M16</b>		<b>19,0</b>	<b>24,0</b>	<b>30,0</b>	<b>17,0</b>	<b>35,0</b>	<b>18,0</b>	<b>18,0</b>	<b>65,0</b>	<b>20</b>	<b>~2,3 kg.</b>	<b>120</b>	<b>~13,8 kg.</b>	
SKP-S1/185-M20	M20		19,0	24,0	30,0	21,0	39,0	22,0	22,0	69,0	20	~2,4 kg.	120	~14,4 kg.	
SKP-S1/240-M10	240		M10	21,0	26,0	35,0	10,5	39,0	21,5	19,0	72,0	20	~3,0 kg.	120	~18,0 kg.
SKP-S1/240-M12			M12	21,0	26,0	35,0	13,0	39,0	21,5	19,0	72,0	20	~3,0 kg.	120	~18,0 kg.
SKP-S1/240-M14		M14	21,0	26,0	35,0	15,0	39,0	21,5	19,0	72,0	20	~3,0 kg.	120	~18,0 kg.	
<b>SKP-S1/240-M16/SD</b>		<b>M16</b>	<b>21,0</b>	<b>26,0</b>	<b>35,0</b>	<b>17,0</b>	<b>39,0</b>	<b>21,5</b>	<b>19,0</b>	<b>72,0</b>	<b>20</b>	<b>~2,9 kg.</b>	<b>120</b>	<b>~17,4 kg.</b>	
SKP-S1/240-M20		M20	21,0	26,0	35,0	21,0	39,0	21,5	19,0	72,0	20	~2,8 kg.	120	~16,8 kg.	
SKP-S1/300-M12		300	M12	23,5	29,5	44,0	13,0	43,0	24,0	24,0	87,0	8	~1,9 kg.	48	~11,4 kg.
SKP-S1/300-M14			M14	23,5	29,5	44,0	15,0	43,0	24,0	24,0	87,0	8	~1,9 kg.	48	~11,4 kg.
SKP-S1/300-M16	M16		23,5	29,5	44,0	17,0	43,0	24,0	24,0	87,0	8	~1,9 kg.	48	~11,4 kg.	
<b>SKP-S1/300-M20/SD</b>	<b>M20</b>		<b>23,5</b>	<b>29,5</b>	<b>44,0</b>	<b>21,0</b>	<b>43,0</b>	<b>24,0</b>	<b>24,0</b>	<b>87,0</b>	<b>8</b>	<b>~1,9 kg.</b>	<b>48</b>	<b>~11,4 kg.</b>	
SKP-S1/400-M12	400		M12	27,0	34,0	44,0	13,0	49,0	24,0	24,0	90,0	6	~2,0 kg.	36	~12,0 kg.
SKP-S1/400-M14			M14	27,0	34,0	44,0	15,0	49,0	24,0	24,0	90,0	6	~2,0 kg.	36	~12,0 kg.
SKP-S1/400-M16			M16	27,0	34,0	44,0	17,0	49,0	24,0	24,0	90,0	6	~2,0 kg.	36	~12,0 kg.
<b>SKP-S1/400-M20/SD</b>		<b>M20</b>	<b>27,0</b>	<b>34,0</b>	<b>44,0</b>	<b>21,0</b>	<b>49,0</b>	<b>24,0</b>	<b>24,0</b>	<b>90,0</b>	<b>6</b>	<b>~1,9 kg.</b>	<b>36</b>	<b>~11,4 kg.</b>	

SKP-S1 SPECIFICATIONS

MATERIAL	ELECTROLYTIC COPPER CONFORMED TO EN 13800
COATING	TIN PLATED
JOINT	CLAMP COUPLING
THICKNESS	VERY THICK
CABLE ENTRY	STANDARD

THE CABLE LUGS WHICH ARE INDICATED IN BOLD FONT, ARE STANDARD PRODUCTS OF **Simpa**



# SKP-S2

## LONG BARREL TUBULAR CABLE LUGS

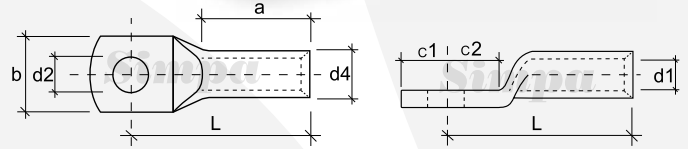

All rights reserved.

Order Code	Cable Section (mm <sup>2</sup> )	Bolt	Dimensions								Box Pcs.	Box Weight	Parcel Pcs.	Box Weight
			d1	d4	a	d2	b	c1	c2	L				
SKP-S2/010-M05	10	M5	4,5	7,0	14,0	5,5	12,0	6,5	7,5	26,0	400	~2,6 kg.	3.200	~20,8 kg.
<b>SKP-S2/010-M06/SD</b>		<b>M6</b>	<b>4,5</b>	<b>7,0</b>	<b>14,0</b>	<b>6,5</b>	<b>12,0</b>	<b>6,2</b>	<b>7,5</b>	<b>26,0</b>	<b>400</b>	<b>~2,4 kg.</b>	<b>3.200</b>	<b>~19,2 kg.</b>
SKP-S2/010-M08		M8	4,5	7,5	14,0	8,5	15,0	10,0	10,0	29,0	400	~2,7 kg.	3.200	~21,6 kg.
SKP-S2/010-M10		M10	4,5	7,5	14,0	10,5	17,0	12,0	12,0	31,0	350	~2,5 kg.	2.800	~20,0 kg.
SKP-S2/010-M12		M12	4,5	7,5	14,0	13,0	19,0	13,0	13,0	33,0	300	~3,0 kg.	2.400	~24,0 kg.
SKP-S2/016-M05	16	M5	5,5	8,5	17,0	5,5	12,0	5,5	6,5	30,0	250	~2,5 kg.	2.000	~20,0 kg.
SKP-S2/016-M06		M6	5,5	8,5	17,0	6,5	12,0	6,2	7,5	31,0	250	~2,6 kg.	2.000	~20,8 kg.
<b>SKP-S2/016-M08/SD</b>		<b>M8</b>	<b>5,5</b>	<b>8,5</b>	<b>17,0</b>	<b>8,4</b>	<b>15,0</b>	<b>8,5</b>	<b>9,5</b>	<b>33,0</b>	<b>250</b>	<b>~2,7 kg.</b>	<b>2.000</b>	<b>~21,6 kg.</b>
SKP-S2/016-M10		M10	5,5	8,5	17,0	10,5	17,0	10,5	11,5	35,0	250	~2,9 kg.	2.000	~23,2 kg.
SKP-S2/016-M12		M12	5,5	8,5	17,0	13,0	19,0	13,0	13,0	37,0	250	~3,1 kg.	2.000	~24,8 kg.
SKP-S2/025-M05	25	M5	7,0	10,0	19,0	5,5	14,0	7,5	7,5	34,0	175	~2,4 kg.	1.400	~19,2 kg.
SKP-S2/025-M06		M6	7,0	10,0	19,0	6,5	14,0	7,5	7,5	34,0	175	~2,4 kg.	1.400	~19,2 kg.
<b>SKP-S2/025-M08/SD</b>		<b>M8</b>	<b>7,0</b>	<b>10,0</b>	<b>19,0</b>	<b>8,4</b>	<b>16,0</b>	<b>10,0</b>	<b>10,0</b>	<b>36,0</b>	<b>175</b>	<b>~2,6 kg.</b>	<b>1.400</b>	<b>~20,8 kg.</b>
SKP-S2/025-M10		M10	7,0	10,0	19,0	10,5	18,0	12,0	12,0	38,0	175	~2,8 kg.	1.400	~22,4 kg.
SKP-S2/025-M12		M12	7,0	10,0	19,0	13,0	19,0	13,0	13,0	39,0	175	~2,7 kg.	1.400	~21,6 kg.
SKP-S2/035-M06	35	M6	8,5	12,0	23,0	6,5	17,0	7,5	7,5	38,0	100	~2,2 kg.	800	~17,6 kg.
<b>SKP-S2/035-M08/SD</b>		<b>M8</b>	<b>8,5</b>	<b>12,0</b>	<b>23,0</b>	<b>8,4</b>	<b>17,0</b>	<b>10,0</b>	<b>10,0</b>	<b>40,0</b>	<b>100</b>	<b>~2,3 kg.</b>	<b>800</b>	<b>~18,4 kg.</b>
SKP-S2/035-M10		M10	8,5	12,0	23,0	10,5	19,0	12,0	12,0	43,0	100	~2,5 kg.	800	~20,0 kg.
SKP-S2/035-M12		M12	8,5	12,0	23,0	13,0	21,0	13,0	13,0	44,0	100	~2,5 kg.	800	~20,0 kg.
SKP-S2/035-M16		M16	8,5	12,0	23,0	17,0	26,0	16,0	16,0	48,0	100	~2,6 kg.	800	~20,8 kg.
SKP-S2/050-M06	50	M6	10,0	14,0	25,0	6,5	20,0	10,0	10,0	43,0	60	~2,1 kg.	480	~16,8 kg.
SKP-S2/050-M08		M8	10,0	14,0	25,0	8,5	20,0	10,0	10,0	43,0	60	~2,0 kg.	480	~16,0 kg.
<b>SKP-S2/050-M10/SD</b>		<b>M10</b>	<b>10,0</b>	<b>14,0</b>	<b>25,0</b>	<b>10,5</b>	<b>20,0</b>	<b>12,0</b>	<b>12,0</b>	<b>45,0</b>	<b>60</b>	<b>~2,1 kg.</b>	<b>480</b>	<b>~16,8 kg.</b>
SKP-S2/050-M12		M12	10,0	14,0	25,0	13,0	23,0	13,0	13,0	49,0	60	~2,3 kg.	480	~18,4 kg.
SKP-S2/050-M16		M16	10,0	14,0	25,0	17,0	28,0	16,0	16,0	52,0	60	~2,3 kg.	480	~18,4 kg.
SKP-S2/050-M20	M20	10,0	14,0	25,0	21,0	30,0	19,0	19,0	54,0	60	~2,3 kg.	480	~18,4 kg.	
SKP-S2/070-M06	70	M6	12,0	16,5	29,0	6,5	23,0	10,0	10,0	51,0	50	~2,7 kg.	400	~21,6 kg.
SKP-S2/070-M08		M8	12,0	16,5	29,0	8,5	23,0	10,0	10,0	51,0	50	~2,6 kg.	400	~20,8 kg.
<b>SKP-S2/070-M10/SD</b>		<b>M10</b>	<b>12,0</b>	<b>16,5</b>	<b>29,0</b>	<b>10,5</b>	<b>23,0</b>	<b>12,0</b>	<b>12,0</b>	<b>52,0</b>	<b>50</b>	<b>~2,7 kg.</b>	<b>400</b>	<b>~21,6 kg.</b>
SKP-S2/070-M12		M12	12,0	16,5	29,0	13,0	23,0	13,0	13,0	54,0	50	~2,7 kg.	400	~21,6 kg.
SKP-S2/070-M16		M16	12,0	16,5	29,0	17,0	28,0	16,0	16,0	58,0	50	~2,9 kg.	400	~23,2 kg.
SKP-S2/070-M20	M20	12,0	16,5	29,0	21,0	30,0	19,0	19,0	61,0	50	~3,0 kg.	400	~24,0 kg.	
SKP-S2/095-M08	95	M8	13,5	18,0	33,0	8,5	26,0	12,0	12,0	56,0	40	~2,6 kg.	320	~20,8 kg.
SKP-S2/095-M10		M10	13,5	18,0	33,0	10,5	26,0	12,0	12,0	56,0	40	~2,6 kg.	320	~20,8 kg.
<b>SKP-S2/095-M12/SD</b>		<b>M12</b>	<b>13,5</b>	<b>18,0</b>	<b>33,0</b>	<b>13,0</b>	<b>26,0</b>	<b>13,0</b>	<b>13,0</b>	<b>57,0</b>	<b>40</b>	<b>~2,6 kg.</b>	<b>320</b>	<b>~20,8 kg.</b>
SKP-S2/095-M16		M16	13,5	18,0	33,0	17,0	28,0	16,0	16,0	62,0	40	~2,7 kg.	320	~21,6 kg.
SKP-S2/095-M20		M20	13,5	18,0	33,0	21,0	36,0	22,0	22,0	68,0	40	~3,1 kg.	320	~24,8 kg.
SKP-S2/120-M08	120	M8	15,0	19,5	36,0	8,5	28,0	14,0	14,0	61,0	30	~2,4 kg.	240	~19,2 kg.
SKP-S2/120-M10		M10	15,0	19,5	36,0	10,5	28,0	14,0	14,0	61,0	30	~2,3 kg.	240	~18,4 kg.
<b>SKP-S2/120-M12/SD</b>		<b>M12</b>	<b>15,0</b>	<b>19,5</b>	<b>36,0</b>	<b>13,0</b>	<b>28,0</b>	<b>14,0</b>	<b>14,0</b>	<b>61,0</b>	<b>30</b>	<b>~2,3 kg.</b>	<b>240</b>	<b>~18,4 kg.</b>
SKP-S2/120-M16		M16	15,0	19,5	36,0	17,0	30,0	16,0	16,0	64,0	30	~2,3 kg.	240	~18,4 kg.
SKP-S2/120-M20		M20	15,0	19,5	36,0	21,0	36,0	22,0	22,0	73,0	30	~2,7 kg.	240	~21,6 kg.

Order Code	Cable Section (mm <sup>2</sup> )	Bolt	Dimensions								Box Pcs.	Box Weight	Parcel Pcs.	Box Weight
			d1	d4	a	d2	b	c1	c2	L				
SKP-S2/150-M08	<b>150</b>	M8	16,5	21,0	40,0	8,5	31,0	14,0	14,0	66,0	25	~2,3 kg.	200	~18,4 kg.
SKP-S2/150-M10		M10	16,5	21,0	40,0	10,5	31,0	14,0	14,0	66,0	25	~2,3 kg.	200	~18,4 kg.
<b>SKP-S2/150-M12/SD</b>		<b>M12</b>	<b>16,5</b>	<b>21,0</b>	<b>40,0</b>	<b>13,0</b>	<b>31,0</b>	<b>15,0</b>	<b>15,0</b>	<b>67,0</b>	<b>25</b>	<b>~2,3 kg.</b>	<b>200</b>	<b>~18,4 kg.</b>
SKP-S2/150-M16		M16	16,5	21,0	40,0	17,0	31,0	16,0	16,0	68,0	25	~2,2 kg.	200	~17,6 kg.
SKP-S2/150-M20		M20	16,5	21,0	40,0	21,0	36,0	22,0	22,0	76,0	25	~2,6 kg.	200	~20,8 kg.
SKP-S2/185-M10	<b>185</b>	M10	19,0	24,0	42,0	10,5	35,0	16,0	16,0	72,5	20	~2,6 kg.	160	~20,8 kg.
<b>SKP-S2/185-M12/SD</b>		<b>M12</b>	<b>19,0</b>	<b>24,0</b>	<b>42,0</b>	<b>13,0</b>	<b>35,0</b>	<b>16,0</b>	<b>16,0</b>	<b>72,5</b>	<b>20</b>	<b>~2,6 kg.</b>	<b>160</b>	<b>~20,8 kg.</b>
SKP-S2/185-M16		M16	19,0	24,0	42,0	17,0	35,0	16,0	16,0	72,5	20	~2,7 kg.	160	~21,6 kg.
SKP-S2/185-M20	M20	19,0	24,0	42,0	21,0	39,0	21,5	19,0	76,5	20	~2,8 kg.	160	~22,4 kg.	
SKP-S2/240-M10	<b>240</b>	M10	21,0	26,0	45,0	10,5	39,0	16,5	16,5	79,0	15	~2,5 kg.	120	~20,0 kg.
<b>SKP-S2/240-M12/SD</b>		<b>M12</b>	<b>21,0</b>	<b>26,0</b>	<b>45,0</b>	<b>13,0</b>	<b>39,0</b>	<b>16,5</b>	<b>16,5</b>	<b>79,0</b>	<b>15</b>	<b>~2,3 kg.</b>	<b>120</b>	<b>~18,4 kg.</b>
SKP-S2/240-M16		M16	21,0	26,0	45,0	17,0	39,0	16,5	16,5	79,0	15	~2,4 kg.	120	~19,2 kg.
SKP-S2/240-M20	M20	21,0	26,0	45,0	21,0	39,0	21,5	19,0	82,0	15	~2,4 kg.	120	~19,2 kg.	
SKP-S2/300-M12	<b>300</b>	M12	23,5	29,5	56,0	13,0	43,0	24,0	24,0	99,0	8	~2,2 kg.	64	~17,6 kg.
SKP-S2/300-M16		M16	23,5	29,5	56,0	17,0	43,0	24,0	24,0	99,0	8	~2,1 kg.	64	~16,8 kg.
<b>SKP-S2/300-M20/SD</b>		<b>M20</b>	<b>23,5</b>	<b>29,5</b>	<b>56,0</b>	<b>21,0</b>	<b>43,0</b>	<b>24,0</b>	<b>24,0</b>	<b>99,0</b>	<b>8</b>	<b>~2,1 kg.</b>	<b>64</b>	<b>~16,8 kg.</b>
SKP-S2/400-M12	<b>400</b>	M12	27,0	34,0	60,0	13,0	49,0	24,0	24,0	106,0	6	~2,3 kg.	48	~18,4 kg.
SKP-S2/400-M16		M16	27,0	34,0	60,0	17,0	49,0	24,0	24,0	106,0	6	~2,3 kg.	48	~18,4 kg.
<b>SKP-S2/400-M20/SD</b>		<b>M20</b>	<b>27,0</b>	<b>34,0</b>	<b>60,0</b>	<b>21,0</b>	<b>49,0</b>	<b>24,0</b>	<b>24,0</b>	<b>106,0</b>	<b>6</b>	<b>~2,2 kg.</b>	<b>48</b>	<b>~17,6 kg.</b>

**SKP-S2 SPECIFICATIONS**

MATERIAL	ELECTROLYTIC COPPER CONFORMED TO EN 13600
COATING	TIN PLATED
JOINT	CLAMP COUPLING
THICKNESS	VERY THICK
CABLE ENTRY	LONG

THE CABLE LUGS WHICH ARE INDICATED IN BOLD FONT, ARE STANDARD PRODUCTS OF **Simpa**



# SKP-S3

## LONGER BARREL TUBULAR CABLE LUGS

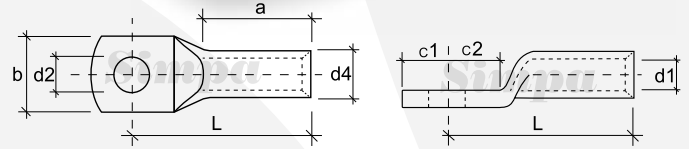
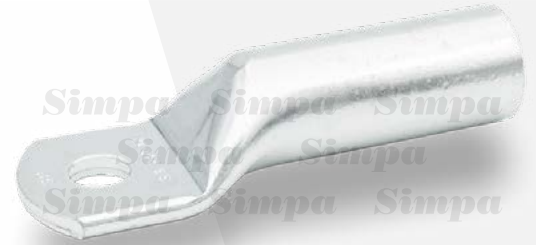

All rights reserved.

Order Code	Cable Section (mm <sup>2</sup> )	Bolt	Dimensions								Box Pcs.	Box Weight	Parcel Pcs.	Box Weight
			d1	d4	a	d2	b	c1	c2	L				
SKP-S3/025-M05	25	M5	7,0	10,0	40,0	5,5	14,0	7,5	7,5	55,0	125	~2,7 kg.	750	~16,2 kg.
SKP-S3/025-M06		M6	7,0	10,0	40,0	6,5	14,0	7,5	7,5	55,0	125	~2,6 kg.	750	~15,6 kg.
<b>SKP-S3/025-M08/SD</b>		<b>M8</b>	<b>7,0</b>	<b>10,0</b>	<b>40,0</b>	<b>8,4</b>	<b>16,0</b>	<b>10,0</b>	<b>10,0</b>	<b>57,0</b>	<b>125</b>	<b>~2,8 kg.</b>	<b>750</b>	<b>~16,8 kg.</b>
SKP-S3/025-M10		M10	7,0	10,0	40,0	10,5	18,0	12,0	12,0	59,0	125	~2,9 kg.	750	~17,4 kg.
SKP-S3/025-M12		M12	7,0	10,0	40,0	13,0	19,0	13,0	13,0	60,0	125	~2,9 kg.	750	~17,4 kg.
SKP-S3/025-M14		M14	7,0	10,0	40,0	15,0	21,0	14,5	14,5	63,0	125	~3,0 kg.	750	~18,0 kg.
SKP-S3/035-M06	35	M6	8,5	12,0	40,0	6,5	17,0	7,5	7,5	55,0	80	~2,4 kg.	480	~14,4 kg.
<b>SKP-S3/035-M08/SD</b>		<b>M8</b>	<b>8,5</b>	<b>12,0</b>	<b>40,0</b>	<b>8,4</b>	<b>17,0</b>	<b>10,0</b>	<b>10,0</b>	<b>57,0</b>	<b>80</b>	<b>~2,4 kg.</b>	<b>480</b>	<b>~14,4 kg.</b>
SKP-S3/035-M10		M10	8,5	12,0	40,0	10,5	19,0	12,0	12,0	60,0	80	~2,7 kg.	480	~16,2 kg.
SKP-S3/035-M12		M12	8,5	12,0	40,0	13,0	21,0	13,0	13,0	61,0	80	~2,7 kg.	480	~16,2 kg.
SKP-S3/035-M14		M14	8,5	12,0	40,0	15,0	21,0	14,5	14,5	63,0	80	~2,7 kg.	480	~16,2 kg.
SKP-S3/035-M16		M16	8,5	12,0	40,0	17,0	26,0	16,0	16,0	65,0	80	~2,8 kg.	480	~16,8 kg.
SKP-S3/050-M06	50	M6	10,0	14,0	50,0	6,5	20,0	10,0	10,0	68,0	50	~2,6 kg.	300	~15,6 kg.
SKP-S3/050-M08		M8	10,0	14,0	50,0	8,5	20,0	10,0	10,0	68,0	50	~2,5 kg.	300	~15,0 kg.
<b>SKP-S3/050-M10/SD</b>		<b>M10</b>	<b>10,0</b>	<b>14,0</b>	<b>50,0</b>	<b>10,5</b>	<b>20,0</b>	<b>12,0</b>	<b>12,0</b>	<b>70,0</b>	<b>50</b>	<b>~2,6 kg.</b>	<b>300</b>	<b>~15,6 kg.</b>
SKP-S3/050-M12		M12	10,0	14,0	50,0	13,0	23,0	13,0	13,0	74,0	50	~2,7 kg.	300	~16,2 kg.
SKP-S3/050-M14		M14	10,0	14,0	50,0	15,0	23,0	14,5	14,5	76,0	50	~2,7 kg.	300	~16,2 kg.
SKP-S3/050-M16		M16	10,0	14,0	50,0	17,0	28,0	16,0	16,0	77,0	50	~2,8 kg.	300	~16,8 kg.
SKP-S3/050-M20	M20	10,0	14,0	50,0	21,0	30,0	19,0	19,0	79,0	50	~2,8 kg.	300	~16,8 kg.	
SKP-S3/070-M06	70	M6	12,0	16,5	50,0	6,5	23,0	10,0	10,0	72,0	40	~2,9 kg.	240	~17,4 kg.
SKP-S3/070-M08		M8	12,0	16,5	50,0	8,5	23,0	10,0	10,0	72,0	40	~2,9 kg.	240	~17,4 kg.
<b>SKP-S3/070-M10/SD</b>		<b>M10</b>	<b>12,0</b>	<b>16,5</b>	<b>50,0</b>	<b>10,5</b>	<b>23,0</b>	<b>12,0</b>	<b>12,0</b>	<b>73,0</b>	<b>40</b>	<b>~2,9 kg.</b>	<b>240</b>	<b>~17,4 kg.</b>
SKP-S3/070-M12		M12	12,0	16,5	50,0	13,0	23,0	13,0	13,0	75,0	40	~3,0 kg.	240	~18,0 kg.
SKP-S3/070-M14		M14	12,0	16,5	50,0	15,0	23,0	14,5	14,5	77,0	40	~3,0 kg.	240	~18,0 kg.
SKP-S3/070-M16		M16	12,0	16,5	50,0	17,0	28,0	16,0	16,0	79,0	40	~3,1 kg.	240	~18,6 kg.
SKP-S3/070-M20	M20	12,0	16,5	50,0	21,0	30,0	19,0	19,0	82,0	40	~3,1 kg.	240	~18,6 kg.	
SKP-S3/095-M08	95	M8	13,5	18,0	50,0	8,5	26,0	12,0	12,0	73,0	30	~2,5 kg.	180	~15,0 kg.
SKP-S3/095-M10		M10	13,5	18,0	50,0	10,5	26,0	12,0	12,0	73,0	30	~2,5 kg.	180	~15,0 kg.
<b>SKP-S3/095-M12/SD</b>		<b>M12</b>	<b>13,5</b>	<b>18,0</b>	<b>50,0</b>	<b>13,0</b>	<b>26,0</b>	<b>13,0</b>	<b>13,0</b>	<b>74,0</b>	<b>30</b>	<b>~2,5 kg.</b>	<b>180</b>	<b>~15,0 kg.</b>
SKP-S3/095-M14		M14	13,5	18,0	50,0	15,0	26,0	14,5	14,5	76,0	30	~2,6 kg.	180	~15,6 kg.
SKP-S3/095-M16		M16	13,5	18,0	50,0	17,0	28,0	16,0	16,0	79,0	30	~2,7 kg.	180	~16,2 kg.
SKP-S3/095-M20		M20	13,5	18,0	50,0	21,0	36,0	22,0	22,0	85,0	30	~2,8 kg.	180	~16,8 kg.
SKP-S3/120-M08	120	M8	15,0	19,5	60,0	8,5	28,0	14,0	14,0	85,0	25	~2,6 kg.	150	~15,6 kg.
SKP-S3/120-M10		M10	15,0	19,5	60,0	10,5	28,0	14,0	14,0	85,0	25	~2,6 kg.	150	~15,6 kg.
<b>SKP-S3/120-M12/SD</b>		<b>M12</b>	<b>15,0</b>	<b>19,5</b>	<b>60,0</b>	<b>13,0</b>	<b>28,0</b>	<b>14,0</b>	<b>14,0</b>	<b>85,0</b>	<b>25</b>	<b>~2,6 kg.</b>	<b>150</b>	<b>~15,6 kg.</b>
SKP-S3/120-M14		M14	15,0	19,5	60,0	15,0	28,0	15,0	15,0	86,0	25	~2,6 kg.	150	~15,6 kg.
SKP-S3/120-M16		M16	15,0	19,5	60,0	17,0	30,0	16,0	16,0	88,0	25	~2,7 kg.	150	~16,2 kg.
SKP-S3/120-M20		M20	15,0	19,5	60,0	21,0	36,0	22,0	22,0	97,0	25	~2,9 kg.	150	~17,4 kg.

Order Code	Cable Section (mm <sup>2</sup> )	Bolt	Dimensions								Box Pcs.	Box Weight	Parcel Pcs.	Box Weight
			d1	d4	a	d2	b	c1	c2	L				
SKP-S3/150-M08	<b>150</b>	M8	16,5	21,0	60,0	8,5	31,0	14,0	14,0	86,0	20	~2,3 kg.	120	~13,8 kg.
SKP-S3/150-M10		M10	16,5	21,0	60,0	10,5	31,0	14,0	14,0	86,0	20	~2,3 kg.	120	~13,8 kg.
<b>SKP-S3/150-M12/SD</b>		<b>M12</b>	<b>16,5</b>	<b>21,0</b>	<b>60,0</b>	<b>13,0</b>	<b>31,0</b>	<b>15,0</b>	<b>15,0</b>	<b>87,0</b>	<b>20</b>	<b>~2,3 kg.</b>	<b>120</b>	<b>~13,8 kg.</b>
SKP-S3/150-M14		M14	16,5	21,0	60,0	15,0	31,0	15,0	15,0	87,0	20	~2,3 kg.	120	~13,8 kg.
SKP-S3/150-M16		M16	16,5	21,0	60,0	17,0	31,0	16,0	16,0	88,0	20	~2,3 kg.	120	~13,8 kg.
SKP-S3/150-M20		M20	16,5	21,0	60,0	21,0	36,0	22,0	22,0	96,0	20	~2,5 kg.	120	~15,0 kg.
SKP-S3/185-M10	<b>185</b>	M10	19,0	24,0	60,0	10,5	35,0	16,0	16,0	92,0	12	~2,0 kg.	72	~12,0 kg.
<b>SKP-S3/185-M12/SD</b>		<b>M12</b>	<b>19,0</b>	<b>24,0</b>	<b>60,0</b>	<b>13,0</b>	<b>35,0</b>	<b>16,0</b>	<b>16,0</b>	<b>92,0</b>	<b>12</b>	<b>~2,0 kg.</b>	<b>72</b>	<b>~12,0 kg.</b>
SKP-S3/185-M14		M14	19,0	24,0	60,0	15,0	35,0	16,0	16,0	92,0	12	~2,0 kg.	72	~12,0 kg.
SKP-S3/185-M16		M16	19,0	24,0	60,0	17,0	35,0	16,0	16,0	92,0	12	~1,9 kg.	72	~11,4 kg.
SKP-S3/185-M20		M20	19,0	24,0	60,0	21,0	39,0	21,5	19,0	96,0	12	~2,0 kg.	72	~12,0 kg.
SKP-S3/240-M08	<b>240</b>	M8	21,0	26,0	60,0	8,5	39,0	16,5	16,5	94,0	12	~2,3 kg.	72	~13,8 kg.
SKP-S3/240-M10		M10	21,0	26,0	60,0	10,5	39,0	16,5	16,5	94,0	12	~2,3 kg.	72	~13,8 kg.
<b>SKP-S3/240-M12/SD</b>		<b>M12</b>	<b>21,0</b>	<b>26,0</b>	<b>60,0</b>	<b>13,0</b>	<b>39,0</b>	<b>16,5</b>	<b>16,5</b>	<b>94,0</b>	<b>12</b>	<b>~2,2 kg.</b>	<b>72</b>	<b>~13,2 kg.</b>
SKP-S3/240-M14		M14	21,0	26,0	60,0	15,0	39,0	16,5	16,5	94,0	12	~2,1 kg.	72	~12,6 kg.
SKP-S3/240-M16		M16	21,0	26,0	60,0	17,0	39,0	16,5	16,5	94,0	12	~2,1 kg.	72	~12,6 kg.
SKP-S3/240-M20		M20	21,0	26,0	60,0	21,0	39,0	21,5	19,0	97,0	12	~2,2 kg.	72	~13,2 kg.

**SKP-S3 SPECIFICATIONS**

MATERIAL	ELECTROLYTIC COPPER CONFORMED TO EN 13600
COATING	TIN PLATED
JOINT	CLAMP COUPLING
THICKNESS	VERY THICK
CABLE ENTRY	VERY LONG

THE CABLE LUGS WHICH ARE INDICATED IN BOLD FONT, ARE STANDARD PRODUCTS OF **Simpa**



# SKP-D

## DIN 46235 TYPE TUBULAR CABLE LUGS

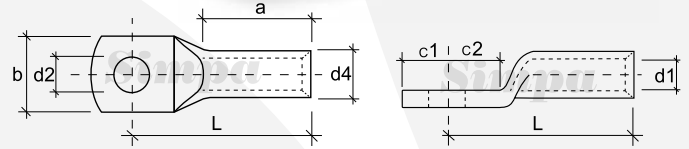

All rights reserved.

Order Code	Cable Section (mm <sup>2</sup> )	Bolt	Dimensions								Box Pcs.	Box Weight	Parcel Pcs.	Box Weight
			d1	d4	a	d2	b	c1	c2	L				
SKP-D/006-M05	6	M5	3,8	5,5	10,0	5,3	8,5	6,5	7,5	24,0	600	~1,9 kg.	3.600	~11,4 kg.
<b>SKP-D/006-M06/SD</b>		<b>M6</b>	<b>3,8</b>	<b>5,5</b>	<b>10,0</b>	<b>6,4</b>	<b>8,5</b>	<b>7,5</b>	<b>8,0</b>	<b>24,0</b>	<b>600</b>	<b>~1,8 kg.</b>	<b>3.600</b>	<b>~10,8 kg.</b>
SKP-D/006-M08		M8	3,8	5,5	10,0	8,4	13,0	10,0	10,0	24,0	600	~1,9 kg.	3.600	~11,4 kg.
SKP-D/010-M05	10	M5	4,5	6,0	10,0	5,3	9,0	7,0	8,5	27,0	500	~1,8 kg.	3.000	~10,8 kg.
<b>SKP-D/010-M06/SD</b>		<b>M6</b>	<b>4,5</b>	<b>6,0</b>	<b>10,0</b>	<b>6,4</b>	<b>9,0</b>	<b>7,5</b>	<b>8,5</b>	<b>27,0</b>	<b>500</b>	<b>~1,7 kg.</b>	<b>3.000</b>	<b>~10,2 kg.</b>
SKP-D/010-M08		M8	4,5	6,0	10,0	8,4	13,0	10,0	10,0	27,0	500	~1,8 kg.	3.000	~10,8 kg.
SKP-D/016-M06	16	M6	5,5	8,5	20,0	6,4	13,0	7,5	8,0	36,0	200	~2,4 kg.	1.200	~14,4 kg.
<b>SKP-D/016-M08/SD</b>		<b>M8</b>	<b>5,5</b>	<b>8,5</b>	<b>20,0</b>	<b>8,4</b>	<b>13,0</b>	<b>10,0</b>	<b>10,0</b>	<b>36,0</b>	<b>200</b>	<b>~2,4 kg.</b>	<b>1.200</b>	<b>~14,4 kg.</b>
SKP-D/016-M10		M10	5,5	8,5	20,0	10,5	17,0	12,0	12,0	36,0	200	~2,4 kg.	1.200	~14,4 kg.
SKP-D/016-M12		M12	5,5	8,5	20,0	13,0	18,0	13,0	13,0	36,0	200	~2,4 kg.	1.200	~14,4 kg.
SKP-D/025-M06	25	M6	7,0	10,0	20,0	6,4	14,0	7,5	8,0	38,0	175	~2,6 kg.	1.050	~15,6 kg.
<b>SKP-D/025-M08/SD</b>		<b>M8</b>	<b>7,0</b>	<b>10,0</b>	<b>20,0</b>	<b>8,4</b>	<b>16,0</b>	<b>10,0</b>	<b>10,0</b>	<b>38,0</b>	<b>175</b>	<b>~2,7 kg.</b>	<b>1.050</b>	<b>~16,2 kg.</b>
SKP-D/025-M10		M10	7,0	10,0	20,0	10,5	17,0	12,0	12,0	38,0	175	~2,7 kg.	1.050	~16,2 kg.
SKP-D/025-M12		M12	7,0	10,0	20,0	13,0	19,0	13,0	13,0	38,0	150	~2,3 kg.	900	~13,8 kg.
SKP-D/035-M06	35	M6	8,2	12,5	20,0	6,4	17,0	7,5	8,0	42,0	100	~2,8 kg.	600	~16,8 kg.
SKP-D/035-M08		M8	8,2	12,5	20,0	8,4	17,0	10,0	10,0	42,0	100	~2,8 kg.	600	~16,8 kg.
<b>SKP-D/035-M10/SD</b>		<b>M10</b>	<b>8,2</b>	<b>12,5</b>	<b>20,0</b>	<b>10,5</b>	<b>19,0</b>	<b>12,0</b>	<b>12,0</b>	<b>42,0</b>	<b>100</b>	<b>~3,0 kg.</b>	<b>600</b>	<b>~18,0 kg.</b>
SKP-D/035-M12		M12	8,2	12,5	20,0	13,0	21,0	13,0	13,0	42,0	100	~2,8 kg.	600	~16,8 kg.
SKP-D/035-M14		M14	8,2	12,5	20,0	15,0	21,0	14,5	14,5	42,0	100	~2,6 kg.	600	~15,6 kg.
SKP-D/050-M08	50	M8	10,0	14,5	28,0	8,4	20,0	10,0	10,0	52,0	60	~2,7 kg.	360	~16,2 kg.
<b>SKP-D/050-M10/SD</b>		<b>M10</b>	<b>10,0</b>	<b>14,5</b>	<b>28,0</b>	<b>10,5</b>	<b>22,0</b>	<b>12,0</b>	<b>12,0</b>	<b>52,0</b>	<b>60</b>	<b>~2,7 kg.</b>	<b>360</b>	<b>~16,2 kg.</b>
SKP-D/050-M12		M12	10,0	14,5	28,0	13,0	24,0	13,0	13,0	52,0	60	~2,7 kg.	360	~16,2 kg.
SKP-D/050-M14		M14	10,0	14,5	28,0	15,0	24,0	14,5	14,5	52,0	60	~2,7 kg.	360	~16,2 kg.
SKP-D/050-M16		M16	10,0	14,5	28,0	17,0	28,0	16,0	16,0	52,0	60	~2,7 kg.	360	~16,2 kg.
SKP-D/070-M08	70	M8	11,5	16,5	28,0	8,4	24,0	10,0	10,0	55,0	50	~3,0 kg.	300	~18,0 kg.
<b>SKP-D/070-M10/SD</b>		<b>M10</b>	<b>11,5</b>	<b>16,5</b>	<b>28,0</b>	<b>10,5</b>	<b>24,0</b>	<b>12,0</b>	<b>12,0</b>	<b>55,0</b>	<b>50</b>	<b>~3,1 kg.</b>	<b>300</b>	<b>~18,6 kg.</b>
SKP-D/070-M12		M12	11,5	16,5	28,0	13,0	24,0	13,0	13,0	55,0	50	~3,0 kg.	300	~18,0 kg.
SKP-D/070-M14		M14	11,5	16,5	28,0	15,0	24,0	14,5	14,5	55,0	50	~3,0 kg.	300	~18,0 kg.
SKP-D/070-M16		M16	11,5	16,5	28,0	17,0	30,0	16,0	16,0	55,0	50	~3,0 kg.	300	~18,0 kg.
SKP-D/095-M08	95	M8	13,5	19,0	35,0	8,4	28,0	12,0	12,0	65,0	35	~3,2 kg.	210	~19,2 kg.
SKP-D/095-M10		M10	13,5	19,0	35,0	10,5	28,0	12,0	12,0	65,0	35	~3,2 kg.	210	~19,2 kg.
<b>SKP-D/095-M12/SD</b>		<b>M12</b>	<b>13,5</b>	<b>19,0</b>	<b>35,0</b>	<b>13,0</b>	<b>28,0</b>	<b>13,0</b>	<b>13,0</b>	<b>65,0</b>	<b>35</b>	<b>~3,1 kg.</b>	<b>210</b>	<b>~18,6 kg.</b>
SKP-D/095-M14		M14	13,5	19,0	35,0	15,0	28,0	14,5	14,5	65,0	35	~3,2 kg.	210	~19,2 kg.
SKP-D/095-M16		M16	13,5	19,0	35,0	17,0	32,0	16,0	16,0	65,0	35	~3,2 kg.	210	~19,2 kg.
SKP-D/120-M10	120	M10	15,5	21,0	35,0	10,5	32,0	15,0	16,0	70,0	30	~3,4 kg.	180	~20,4 kg.
<b>SKP-D/120-M12/SD</b>		<b>M12</b>	<b>15,5</b>	<b>21,0</b>	<b>35,0</b>	<b>13,0</b>	<b>32,0</b>	<b>16,0</b>	<b>17,0</b>	<b>70,0</b>	<b>30</b>	<b>~3,4 kg.</b>	<b>180</b>	<b>~20,4 kg.</b>
SKP-D/120-M14		M14	15,5	21,0	35,0	15,0	32,0	18,0	19,0	70,0	30	~3,4 kg.	180	~20,4 kg.
SKP-D/120-M16		M16	15,5	21,0	35,0	17,0	32,0	19,0	20,0	70,0	30	~3,4 kg.	180	~20,4 kg.
SKP-D/120-M20		M20	15,5	21,0	35,0	21,0	38,0	21,0	22,0	70,0	30	~3,4 kg.	180	~20,4 kg.

Order Code	Cable Section (mm <sup>2</sup> )	Bolt	Dimensions								Box Pcs.	Box Weight	Parcel Pcs.	Box Weight
			d1	d4	a	d2	b	c1	c2	L				
SKP-D/150-M10	<b>150</b>	M10	17,0	23,5	35,0	10,5	34,0	15,0	16,0	78,0	15	~2,5 kg.	90	~15,0 kg.
<b>SKP-D/150-M12/SD</b>		<b>M12</b>	<b>17,0</b>	<b>23,5</b>	<b>35,0</b>	<b>13,0</b>	<b>34,0</b>	<b>16,0</b>	<b>17,0</b>	<b>78,0</b>	<b>15</b>	<b>~2,5 kg.</b>	<b>90</b>	<b>~15,0 kg.</b>
SKP-D/150-M14		M14	17,0	23,5	35,0	15,0	34,0	19,0	20,0	78,0	15	~2,5 kg.	90	~15,0 kg.
SKP-D/150-M16		M16	17,0	23,5	35,0	17,0	34,0	19,0	20,0	78,0	15	~2,5 kg.	90	~15,0 kg.
SKP-D/150-M20		M20	17,0	23,5	35,0	21,0	40,0	21,0	22,0	78,0	15	~2,4 kg.	90	~14,4 kg.
SKP-D/185-M10	<b>185</b>	M10	19,0	25,5	40,0	10,5	37,0	15,0	16,0	82,0	12	~2,3 kg.	72	~13,8 kg.
<b>SKP-D/185-M12/SD</b>		<b>M12</b>	<b>19,0</b>	<b>25,5</b>	<b>40,0</b>	<b>13,0</b>	<b>37,0</b>	<b>16,0</b>	<b>17,0</b>	<b>82,0</b>	<b>12</b>	<b>~2,3 kg.</b>	<b>72</b>	<b>~13,8 kg.</b>
SKP-D/185-M14		M14	19,0	25,5	40,0	15,0	37,0	19,0	20,0	82,0	12	~2,3 kg.	72	~13,8 kg.
SKP-D/185-M16		M16	19,0	25,5	40,0	17,0	37,0	19,0	20,0	82,0	12	~2,3 kg.	72	~13,8 kg.
SKP-D/185-M20		M20	19,0	25,5	40,0	21,0	40,0	21,0	22,0	82,0	12	~2,2 kg.	72	~13,2 kg.
<b>SKP-D/240-M12/SD</b>	<b>240</b>	<b>M12</b>	<b>21,5</b>	<b>29,0</b>	<b>40,0</b>	<b>13,0</b>	<b>42,0</b>	<b>16,0</b>	<b>17,0</b>	<b>92,0</b>	<b>8</b>	<b>~2,2 kg.</b>	<b>48</b>	<b>~13,2 kg.</b>
SKP-D/240-M14		M14	21,5	29,0	40,0	15,0	42,0	19,0	20,0	92,0	8	~2,3 kg.	48	~13,8 kg.
SKP-D/240-M16		M16	21,5	29,0	40,0	17,0	42,0	19,0	20,0	92,0	8	~2,2 kg.	48	~13,2 kg.
SKP-D/240-M20		M20	21,5	29,0	40,0	21,0	45,0	21,0	22,0	92,0	8	~2,2 kg.	48	~13,2 kg.
SKP-D/300-M14		<b>300</b>	M14	24,5	32,0	50,0	15,0	48,0	19,0	22,0	100,0	8	~2,7 kg.	48
<b>SKP-D/300-M16/SD</b>	<b>M16</b>		<b>24,5</b>	<b>32,0</b>	<b>50,0</b>	<b>17,0</b>	<b>48,0</b>	<b>19,0</b>	<b>22,0</b>	<b>100,0</b>	<b>8</b>	<b>~2,7 kg.</b>	<b>48</b>	<b>~16,2 kg.</b>
SKP-D/300-M20	M20		24,5	32,0	50,0	21,0	48,0	22,0	22,0	100,0	8	~2,7 kg.	48	~16,2 kg.
SKP-D/400-M14	<b>400</b>	M14	27,5	38,5	70,0	15,0	55,0	25,0	25,0	115,0	5	~3,4 kg.	30	~20,4 kg.
<b>SKP-D/400-M16/SD</b>		<b>M16</b>	<b>27,5</b>	<b>38,5</b>	<b>70,0</b>	<b>17,0</b>	<b>55,0</b>	<b>25,0</b>	<b>25,0</b>	<b>115,0</b>	<b>5</b>	<b>~3,3 kg.</b>	<b>30</b>	<b>~19,8 kg.</b>
SKP-D/400-M20		M20	27,5	38,5	70,0	21,0	55,0	25,0	25,0	115,0	5	~3,2 kg.	30	~19,2 kg.
SKP-D/500-M16	<b>500</b>	M16	31,0	42,0	70,0	17,0	60,0	25,0	25,0	125,0	4	~3,4 kg.	24	~20,4 kg.
<b>SKP-D/500-M20/SD</b>		<b>M20</b>	<b>31,0</b>	<b>42,0</b>	<b>70,0</b>	<b>21,0</b>	<b>60,0</b>	<b>25,0</b>	<b>25,0</b>	<b>125,0</b>	<b>4</b>	<b>~3,3 kg.</b>	<b>24</b>	<b>~19,8 kg.</b>
SKP-D/625-M16	<b>625</b>	M16	34,5	44,0	80,0	17,0	60,0	25,0	25,0	135,0	3	~2,6 kg.	18	~15,6 kg.
<b>SKP-D/625-M20/SD</b>		<b>M20</b>	<b>34,5</b>	<b>44,0</b>	<b>80,0</b>	<b>21,0</b>	<b>60,0</b>	<b>25,0</b>	<b>25,0</b>	<b>135,0</b>	<b>3</b>	<b>~2,5 kg.</b>	<b>18</b>	<b>~15,0 kg.</b>
SKP-D/800-M16	<b>800</b>	M16	40,0	52,0	100,0	17,0	75,0	30,0	30,0	165,0	4	~6,2 kg.	8	~12,4 kg.
<b>SKP-D/800-M20/SD</b>		<b>M20</b>	<b>40,0</b>	<b>52,0</b>	<b>100,0</b>	<b>21,0</b>	<b>75,0</b>	<b>30,0</b>	<b>30,0</b>	<b>165,0</b>	<b>4</b>	<b>~6,0 kg.</b>	<b>8</b>	<b>~12,0 kg.</b>
SKP-D/1000-M16	<b>1000</b>	M16	44,0	58,0	100,0	17,0	85,0	30,0	30,0	165,0	4	~8,0 kg.	24	~48,0 kg.
<b>SKP-D/1000-M20/SD</b>		<b>M20</b>	<b>44,0</b>	<b>58,0</b>	<b>100,0</b>	<b>21,0</b>	<b>85,0</b>	<b>30,0</b>	<b>30,0</b>	<b>165,0</b>	<b>4</b>	<b>~7,4 kg.</b>	<b>24</b>	<b>~44,4 kg.</b>

**SKP-D SPECIFICATIONS**

MATERIAL	ELECTROLYTIC COPPER CONFORMED TO EN 13600
COATING	TIN PLATED
JOINT	CLAMP COUPLING
CONFORMED TO DIN 46235	

THE CABLE LUGS WHICH ARE INDICATED IN BOLD FONT, ARE STANDARD PRODUCTS OF **Simpa**



# SKP-D1

DIN 46234 TYPE CABLE LUGS

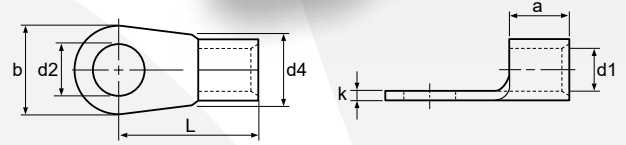

All rights reserved.

Order Code	Cable Section (mm <sup>2</sup> )	Bolt	Dimensions							Box Pcs.	Box Weight	Parcel Pcs.	Box Weight
			d1	d4	a	d2	b	L	K				
SKP-D1/001.5-M03	1,5	M3	1,6	4,0	5,0	3,2	6,0	11,0	0,8	1.000	~0,6 kg.	6.000	~3,6 kg.
SKP-D1/001.5-M04		M4	1,6	4,0	5,0	4,3	8,0	12,0	0,8	1.000	~0,7 kg.	6.000	~4,2 kg.
SKP-D1/001.5-M05		M5	1,6	4,0	5,0	5,3	10,0	13,0	0,8	1.000	~0,8 kg.	6.000	~4,8 kg.
SKP-D1/001.5-M06		M6	1,6	4,0	5,0	6,5	11,0	15,0	0,8	1.000	~0,7 kg.	6.000	~4,2 kg.
SKP-D1/001.5-M08		M8	1,6	4,0	5,0	8,4	14,0	17,0	0,8	1.000	~1,3 kg.	6.000	~7,8 kg.
SKP-D1/001.5-M10		M10	1,6	4,0	5,0	10,5	18,0	19,0	0,8	1.000	~1,8 kg.	6.000	~10,8 kg.
SKP-D1/002.5-M03	2,5	M3	2,3	4,5	5,0	3,2	6,0	11,0	0,8	1.000	~0,7 kg.	6.000	~4,2 kg.
SKP-D1/002.5-M04		M4	2,3	4,5	5,0	4,3	8,0	12,0	0,8	1.000	~0,8 kg.	6.000	~4,8 kg.
SKP-D1/002.5-M05		M5	2,3	4,5	5,0	5,3	10,0	14,0	0,8	1.000	~1,0 kg.	6.000	~6,0 kg.
SKP-D1/002.5-M06		M6	2,3	4,5	5,0	6,5	11,0	16,0	0,8	1.000	~1,1 kg.	6.000	~6,6 kg.
SKP-D1/002.5-M08		M8	2,3	4,5	5,0	8,4	14,0	17,0	0,8	1.000	~1,3 kg.	6.000	~7,8 kg.
SKP-D1/002.5-M10		M10	2,3	4,5	5,0	10,5	17,0	19,5	0,8	1.000	~1,9 kg.	6.000	~11,4 kg.
SKP-D1/002.5-M12	M12	2,3	4,5	5,0	13,0	17,0	20,0	0,8	1.000	~1,7 kg.	6.000	~10,2 kg.	
SKP-D1/006-M04	6	M4	3,6	6,0	6,0	4,3	8,0	14,0	1,0	1.000	~1,4 kg.	6.000	~8,4 kg.
SKP-D1/006-M05		M5	3,6	6,0	6,0	5,3	10,0	15,0	1,0	1.000	~1,6 kg.	6.000	~9,6 kg.
SKP-D1/006-M06		M6	3,6	6,0	6,0	6,5	11,0	16,0	1,0	1.000	~1,7 kg.	6.000	~10,2 kg.
SKP-D1/006-M08		M8	3,6	6,0	6,0	8,4	14,0	19,0	1,0	500	~1,1 kg.	3.000	~6,6 kg.
SKP-D1/006-M10		M10	3,6	6,0	6,0	10,5	18,0	21,0	1,0	500	~1,4 kg.	3.000	~8,4 kg.
SKP-D1/006-M12		M12	3,6	6,0	6,0	13,0	18,0	21,0	1,0	500	~1,4 kg.	3.000	~8,4 kg.
SKP-D1/010-M05	10	M5	4,5	8,0	8,0	5,3	10,0	16,0	1,1	500	~1,2 kg.	3.000	~7,2 kg.
SKP-D1/010-M06		M6	4,5	8,0	8,0	6,5	11,0	17,0	1,1	500	~1,3 kg.	3.000	~7,8 kg.
SKP-D1/010-M08		M8	4,5	8,0	8,0	8,4	14,0	20,0	1,1	500	~1,5 kg.	3.000	~9,0 kg.
SKP-D1/010-M10		M10	4,5	8,0	8,0	10,5	18,0	21,0	1,1	500	~1,8 kg.	3.000	~10,8 kg.
SKP-D1/010-M12		M12	4,5	8,0	8,0	13,0	22,0	23,0	1,1	250	~1,1 kg.	1.500	~6,6 kg.
SKP-D1/016-M05	16	M5	5,8	10,5	10,0	5,3	11,0	20,0	1,2	500	~1,9 kg.	3.000	~11,4 kg.
SKP-D1/016-M06		M6	5,8	10,5	10,0	6,5	11,0	20,0	1,2	500	~2,0 kg.	3.000	~12,0 kg.
SKP-D1/016-M08		M8	5,8	10,5	10,0	8,4	14,0	22,0	1,2	250	~1,1 kg.	1.500	~6,6 kg.
SKP-D1/016-M10		M10	5,8	10,5	10,0	10,5	18,0	24,0	1,2	200	~1,3 kg.	1.500	~7,5 kg.
SKP-D1/016-M12		M12	5,8	10,5	10,0	13,0	22,0	26,0	1,2	200	~1,2 kg.	1.200	~7,2 kg.
SKP-D1/025-M05	25	M5	7,5	12,0	11,0	5,3	12,0	25,0	1,5	200	~1,4 kg.	1.200	~8,4 kg.
SKP-D1/025-M06		M6	7,5	12,0	11,0	6,5	12,0	25,0	1,5	200	~1,2 kg.	1.200	~7,2 kg.
SKP-D1/025-M08		M8	7,5	12,0	11,0	8,4	16,0	25,0	1,5	200	~1,6 kg.	1.200	~9,6 kg.
SKP-D1/025-M10		M10	7,5	12,0	11,0	10,5	18,0	26,0	1,5	200	~1,7 kg.	1.200	~10,2 kg.
SKP-D1/025-M12		M12	7,5	12,0	11,0	13,0	22,0	31,0	1,5	100	~1,0 kg.	600	~6,0 kg.
SKP-D1/025-M14		M14	7,5	12,0	11,0	15,0	22,0	35,0	1,5	100	~0,9 kg.	600	~5,4 kg.
SKP-D1/025-M16	M16	7,5	12,0	11,0	17,0	28,0	35,0	1,5	100	~0,9 kg.	600	~5,4 kg.	
SKP-D1/035-M06	35	M6	9,0	15,0	12,0	6,5	15,0	26,0	1,6	200	~2,0 kg.	1.200	~12,0 kg.
SKP-D1/035-M08		M8	9,0	15,0	12,0	8,4	16,0	26,0	1,6	200	~2,0 kg.	1.200	~12,0 kg.
SKP-D1/035-M10		M10	9,0	15,0	12,0	10,5	18,0	27,0	1,6	100	~1,0 kg.	600	~6,0 kg.
SKP-D1/035-M12		M12	9,0	15,0	12,0	13,0	22,0	31,0	1,6	100	~1,2 kg.	600	~7,2 kg.
SKP-D1/035-M14		M14	9,0	15,0	12,0	15,0	22,0	31,0	1,6	100	~1,4 kg.	600	~8,4 kg.
SKP-D1/035-M16		M16	9,0	15,0	12,0	17,0	28,0	36,0	1,6	100	~1,5 kg.	600	~9,0 kg.

Order Code	Cable Section (mm <sup>2</sup> )	Bolt	Dimensions							Box Pcs.	Box Weight	Parcel Pcs.	Box Weight
			d1	d4	a	d2	b	L	K				
SKP-D1/050-M06	50	M6	11,0	17,0	16,0	6,5	18,0	34,0	1,8	100	~1,8 kg.	600	~10,8 kg.
SKP-D1/050-M08		M8	11,0	17,0	16,0	8,4	18,0	34,0	1,8	100	~1,8 kg.	600	~10,8 kg.
SKP-D1/050-M10		M10	11,0	17,0	16,0	10,5	18,0	34,0	1,8	100	~1,7 kg.	600	~10,2 kg.
SKP-D1/050-M12		M12	11,0	17,0	16,0	13,0	22,0	36,0	1,8	100	~2,0 kg.	600	~12,0 kg.
SKP-D1/050-M14		M14	11,0	17,0	16,0	15,0	22,0	36,0	1,8	100	~2,0 kg.	600	~12,0 kg.
SKP-D1/050-M16		M16	11,0	17,0	16,0	17,0	28,0	40,0	1,8	50	~1,1 kg.	300	~6,6 kg.
SKP-D1/070-M06	70	M6	13,0	21,0	18,0	6,5	22,0	38,0	2,0	50	~1,4 kg.	300	~8,4 kg.
SKP-D1/070-M08		M8	13,0	21,0	18,0	8,4	22,0	38,0	2,0	50	~1,3 kg.	300	~7,8 kg.
SKP-D1/070-M10		M10	13,0	21,0	18,0	10,5	22,0	38,0	2,0	50	~1,3 kg.	300	~7,8 kg.
SKP-D1/070-M12		M12	13,0	21,0	18,0	13,0	22,0	38,0	2,0	50	~1,3 kg.	300	~7,8 kg.
SKP-D1/070-M14		M14	13,0	21,0	18,0	15,0	22,0	38,0	2,0	50	~1,3 kg.	300	~7,8 kg.
SKP-D1/070-M16		M16	13,0	21,0	18,0	17,0	28,0	42,0	2,0	50	~1,4 kg.	300	~8,4 kg.
SKP-D1/095-M06	95	M6	15,0	23,0	20,0	6,5	24,0	42,0	2,5	50	~2,1 kg.	300	~12,6 kg.
SKP-D1/095-M08		M8	15,0	23,0	20,0	8,4	24,0	42,0	2,5	50	~2,0 kg.	300	~12,0 kg.
SKP-D1/095-M10		M10	15,0	23,0	20,0	10,5	24,0	42,0	2,5	50	~2,0 kg.	300	~12,0 kg.
SKP-D1/095-M12		M12	15,0	23,0	20,0	13,0	24,0	42,0	2,5	50	~2,0 kg.	300	~12,0 kg.
SKP-D1/095-M14		M14	15,0	23,0	20,0	15,0	24,0	42,0	2,5	50	~2,0 kg.	300	~12,0 kg.
SKP-D1/095-M16		M16	15,0	23,0	20,0	17,0	28,0	44,0	2,5	25	~1,1 kg.	150	~6,6 kg.
SKP-D1/120-M06	120	M6	16,5	24,0	22,0	6,5	24,0	44,0	3,0	25	~1,4 kg.	150	~8,4 kg.
SKP-D1/120-M08		M8	16,5	24,0	22,0	8,4	24,0	44,0	3,0	25	~1,5 kg.	150	~9,0 kg.
SKP-D1/120-M10		M10	16,5	24,0	22,0	10,5	24,0	44,0	3,0	25	~1,4 kg.	150	~8,4 kg.
SKP-D1/120-M12		M12	16,5	24,0	22,0	13,0	24,0	44,0	3,0	25	~1,4 kg.	150	~8,4 kg.
SKP-D1/120-M14		M14	16,5	24,0	22,0	15,0	24,0	44,0	3,0	25	~1,5 kg.	150	~9,0 kg.
SKP-D1/120-M16		M16	16,5	24,0	22,0	17,0	28,0	48,0	3,0	25	~1,5 kg.	150	~9,0 kg.
SKP-D1/150-M06	150	M06	19,0	28,0	24,0	6,5	30,0	50,0	3,2	20	~1,6 kg.	120	~9,6 kg.
SKP-D1/150-M08		M08	19,0	28,0	24,0	8,4	30,0	50,0	3,2	20	~1,6 kg.	120	~9,6 kg.
SKP-D1/150-M10		M10	19,0	28,0	24,0	10,5	30,0	50,0	3,2	20	~1,7 kg.	120	~10,2 kg.
SKP-D1/150-M12		M12	19,0	28,0	24,0	13,0	30,0	50,0	3,2	20	~1,6 kg.	120	~9,6 kg.
SKP-D1/150-M14		M14	19,0	28,0	24,0	15,0	30,0	50,0	3,2	20	~1,7 kg.	120	~10,2 kg.
SKP-D1/150-M16		M16	19,0	28,0	24,0	17,0	30,0	50,0	3,2	20	~1,6 kg.	120	~10,2 kg.
SKP-D1/185-M10	185	M10	21,0	33,0	28,0	10,5	36,0	50,0	3,5	20	~2,2 kg.	120	~13,2 kg.
SKP-D1/185-M12		M12	21,0	33,0	28,0	13,0	36,0	50,0	3,5	20	~2,2 kg.	120	~13,2 kg.
SKP-D1/185-M14		M14	21,0	33,0	28,0	15,0	36,0	50,0	3,5	20	~1,8 kg.	120	~10,8 kg.
SKP-D1/185-M16		M16	21,0	33,0	28,0	17,0	36,0	50,0	3,5	20	~1,7 kg.	120	~10,2 kg.
SKP-D1/240-M10	240	M10	23,5	36,0	32,0	10,5	38,0	56,0	4,0	10	~1,6 kg.	60	~9,6 kg.
SKP-D1/240-M12		M12	23,5	36,0	32,0	13,0	38,0	56,0	4,0	10	~1,5 kg.	60	~9,0 kg.
SKP-D1/240-M14		M14	23,5	36,0	32,0	15,0	38,0	56,0	4,0	10	~1,6 kg.	60	~9,6 kg.
SKP-D1/240-M16		M16	23,5	36,0	32,0	17,0	38,0	56,0	4,0	10	~1,5 kg.	60	~9,0 kg.

**SKP-D1 SPECIFICATIONS**

MATERIAL	E-CU COPPER
COATING	TIN PLATED
JOINT	CLAMP COUPLING
CONFORMED TO	DIN 46234



# SKP-S/GD

TUBULAR CABLE LUGS WITH INSPECTION HOLE

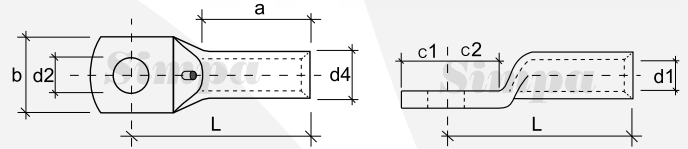

All rights reserved.

Order Code	Cable Section (mm <sup>2</sup> )	Bolt	Dimensions								Box Pcs.	Box Weight	Parcel Pcs.	Box Weight
			d1	d4	a	d2	b	c1	c2	L				
SKP-S/GD/016-M06/SD	<b>16</b>	M06	5,5	7,5	12,5	6,5	12,0	7,5	7,5	24,0	400	~2,0 kg.	3.200	~16,0 kg.
SKP-S/GD/025-M08/SD	<b>25</b>	M08	7,0	9,5	17,5	8,5	14,0	8,5	8,5	30,5	300	~2,5 kg.	2.400	~20,0 kg.
SKP-S/GD/035-M08/SD	<b>35</b>	M08	8,5	11,0	19,0	8,5	16,5	9,5	9,5	34,5	200	~2,6 kg.	1.600	~20,8 kg.
SKP-S/GD/050-M10/SD	<b>50</b>	M10	10,0	13,0	20,0	10,5	19,0	11,0	11,0	39,5	125	~2,6 kg.	1.000	~20,8 kg.
SKP-S/GD/070-M10/SD	<b>70</b>	M10	11,5	14,5	21,5	10,5	21,0	11,0	11,0	41,5	80	~2,1 kg.	640	~16,8 kg.
SKP-S/GD/095-M12/SD	<b>95</b>	M12	13,5	16,5	25,0	13,0	24,0	12,5	12,5	48,0	60	~1,9 kg.	480	~15,2 kg.
SKP-S/GD/120-M12/SD	<b>120</b>	M12	14,5	18,0	27,0	13,0	26,5	14,0	14,0	52,0	50	~2,4 kg.	400	~19,2 kg.
SKP-S/GD/150-M12/SD	<b>150</b>	M12	16,5	21,0	29,0	13,0	30,5	15,0	15,0	57,0	30	~2,4 kg.	240	~19,2 kg.
SKP-S/GD/185-M12/SD	<b>185</b>	M12	18,5	23,0	33,0	13,0	33,5	16,0	16,0	63,0	20	~1,9 kg.	160	~15,2 kg.
SKP-S/GD/240-M12/SD	<b>240</b>	M12	21,0	26,0	37,0	13,0	38,0	16,5	16,5	70,0	20	~2,7 kg.	160	~21,6 kg.

## SKP-S/GD SPECIFICATIONS

MATERIAL	ELECTROLYTIC COPPER CONFORMED TO EN 13800
COATING	TIN PLATED
JOINT	CLAMP COUPLING
THICKNESS	THICK
CABLE ENTRY	STANDARD





# SKP-DG

TUBULAR CABLE LUGS  
FOR SWITCH GEAR CONNECTIONS

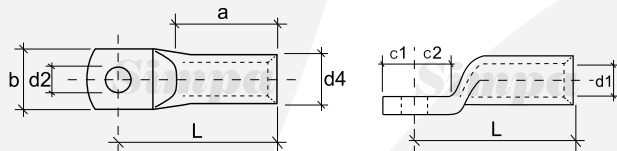

All rights reserved.

Order Code	Cable Section (mm <sup>2</sup> )	Bolt	Dimensions								Box Pcs.	Box Weight	Parcel Pcs.	Box Weight
			d1	d4	a	d2	b	c1	c2	L				
SKP-DG/035-M06	35	M6	8,5	12,0	17,0	6,5	15,0	7,5	7,5	32,0	150	~2,7 kg.	900	~16,2 kg.
SKP-DG/050-M06		M6	10,0	14,0	19,0	6,5	15,0	10,0	10,0	37,0	100	~2,9 kg.	600	~17,4 kg.
SKP-DG/050-M08	50	M8	10,0	14,0	19,0	8,5	17,0	10,0	10,0	37,0	100	~2,8 kg.	600	~16,8 kg.
SKP-DG/050-M10		M10	10,0	14,0	19,0	10,5	19,0	11,5	12,0	39,0	100	~3,1 kg.	600	~18,6 kg.
SKP-DG/070-M06	70	M6	12,0	16,5	21,0	6,5	17,0	10,0	10,0	43,0	80	~3,4 kg.	480	~20,4 kg.
SKP-DG/070-M08		M8	12,0	16,5	21,0	8,5	17,0	10,0	10,0	43,0	80	~3,3 kg.	480	~19,8 kg.
SKP-DG/070-M10		M10	12,0	16,5	21,0	10,5	19,0	11,5	12,0	44,0	80	~3,6 kg.	480	~21,6 kg.
SKP-DG/070-M12		M12	12,0	16,5	21,0	13,0	19,0	13,0	13,0	46,0	80	~3,4 kg.	480	~20,4 kg.
SKP-DG/095-M06	95	M6	13,5	18,0	25,0	6,5	19,0	11,5	12,0	48,0	60	~3,3 kg.	360	~19,8 kg.
SKP-DG/095-M08		M8	13,5	18,0	25,0	8,5	19,0	11,5	12,0	48,0	60	~3,3 kg.	360	~19,8 kg.
SKP-DG/095-M10		M10	13,5	18,0	25,0	10,5	19,0	11,5	12,0	48,0	60	~3,1 kg.	360	~18,6 kg.
SKP-DG/095-M12		M12	13,5	18,0	25,0	13,0	19,0	13,0	13,0	49,0	60	~3,1 kg.	360	~18,6 kg.
SKP-DG/120-M06	120	M6	15,0	19,5	26,0	6,5	19,0	11,5	14,0	51,0	50	~3,1 kg.	300	~18,6 kg.
SKP-DG/120-M08		M8	15,0	19,5	26,0	8,5	19,0	11,5	14,0	51,0	50	~3,0 kg.	300	~18,0 kg.
SKP-DG/120-M10		M10	15,0	19,5	26,0	10,5	19,0	11,5	14,0	51,0	50	~2,9 kg.	300	~17,4 kg.
SKP-DG/120-M12		M12	15,0	19,5	26,0	13,0	19,0	14,0	14,0	51,0	50	~3,0 kg.	300	~18,0 kg.
SKP-DG/150-M06	150	M6	16,5	21,0	30,0	6,5	19,0	11,5	14,0	56,0	35	~2,4 kg.	210	~14,4 kg.
SKP-DG/150-M08		M8	16,5	21,0	30,0	8,5	19,0	11,5	14,0	56,0	35	~2,4 kg.	210	~14,4 kg.
SKP-DG/150-M10		M10	16,5	21,0	30,0	10,5	19,0	11,5	14,0	56,0	35	~2,4 kg.	210	~14,4 kg.
SKP-DG/150-M12		M12	16,5	21,0	30,0	13,0	19,0	15,0	15,0	57,0	35	~2,5 kg.	210	~15,0 kg.
SKP-DG/185-M10	185	M10	19,0	24,0	30,0	10,5	24,5	11,5	18,0	65,0	25	~2,7 kg.	150	~16,2 kg.
SKP-DG/185-M12		M12	19,0	24,0	30,0	13,0	31,0	18,0	18,0	65,0	25	~2,8 kg.	150	~16,8 kg.
SKP-DG/185-M16		M16	19,0	24,0	30,0	17,0	31,0	18,0	18,0	65,0	25	~2,4 kg.	150	~14,4 kg.
SKP-DG/240-M10	240	M10	21,0	26,0	35,0	10,5	31,0	11,5	19,0	72,0	20	~2,5 kg.	120	~15,0 kg.
SKP-DG/240-M12		M12	21,0	26,0	35,0	13,0	31,0	21,5	19,0	72,0	20	~2,8 kg.	120	~16,8 kg.
SKP-DG/240-M16		M16	21,0	26,0	35,0	17,0	31,0	21,5	19,0	72,0	20	~2,7 kg.	120	~16,2 kg.
SKP-DG/300-M10	300	M10	23,5	29,5	44,0	10,5	31,0	11,5	24,0	87,0	10	~2,0 kg.	60	~12,0 kg.
SKP-DG/300-M12		M12	23,5	29,5	44,0	13,0	31,0	24,0	24,0	87,0	10	~2,3 kg.	60	~13,8 kg.
SKP-DG/300-M16		M16	23,5	29,5	44,0	17,0	31,0	24,0	24,0	87,0	10	~2,3 kg.	60	~13,8 kg.

**SKP-DG SPECIFICATIONS**

MATERIAL	ELECTROLYTIC COPPER CONFORMED TO EN 13600
COATING	TIN PLATED
JOINT	CLAMP COUPLING / FOR REDUCED CONNECTING
THICKNESS	VERY THICK
CABLE ENTRY	VERY LONG

UPON REQUEST, IT IS AVAILABLE IN 45 & 90 DEGREES.



# SKP-L90-S1

EUROPE TYPE (S1) 90° ANGULAR CABLE LUGS

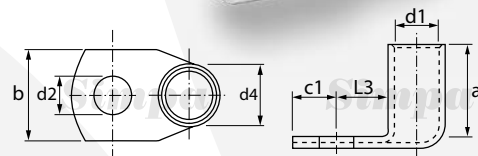

All rights reserved.

Order Code	Cable Section (mm <sup>2</sup> )	Bolt	Dimensions							Box Pcs.	Box Weight	Parcel Pcs.	Box Weight
			d1	d4	a	d2	b	c1	L3				
SKP-L90-S1/006-M05	6	M5	3,5	6,5	13,0	5,5	10,0	7,5	9,0	500	~3,2 kg.	3.000	~19,2 kg.
SKP-L90-S1/006-M06		M6	3,5	6,5	13,0	6,5	12,0	7,5	10,0	500	~3,3 kg.	3.000	~19,8 kg.
SKP-L90-S1/006-M08		M8	3,5	6,5	13,0	8,5	14,0	10,0	13,0	500	~3,3 kg.	3.000	~19,8 kg.
SKP-L90-S1/010-M05	10	M5	4,5	7,5	14,0	5,5	12,0	6,5	10,0	400	~2,4 kg.	2.400	~14,4 kg.
SKP-L90-S1/010-M06		M6	4,5	7,5	14,0	6,5	12,0	6,5	10,0	400	~2,3 kg.	2.400	~13,8 kg.
SKP-L90-S1/010-M08		M8	4,5	7,5	14,0	8,5	15,0	10,0	13,0	300	~2,0 kg.	1.800	~12,0 kg.
SKP-L90-S1/016-M05	16	M5	5,5	8,5	17,0	5,5	12,0	7,5	10,0	300	~3,3 kg.	1.800	~19,8 kg.
SKP-L90-S1/016-M06		M6	5,5	8,5	17,0	6,5	12,0	7,5	11,0	300	~3,4 kg.	1.800	~20,4 kg.
SKP-L90-S1/016-M08		M8	5,5	8,5	17,0	8,5	15,0	10,0	13,0	250	~3,0 kg.	1.500	~18,0 kg.
SKP-L90-S1/016-M10		M10	5,5	8,5	17,0	10,5	17,0	12,0	15,0	200	~2,3 kg.	1.200	~13,8 kg.
SKP-L90-S1/025-M05	25	M5	7,0	10,0	19,0	5,5	14,0	7,5	11,0	200	~3,3 kg.	1.200	~19,8 kg.
SKP-L90-S1/025-M06		M6	7,0	10,0	19,0	6,5	14,0	7,5	11,0	200	~3,3 kg.	1.200	~19,8 kg.
SKP-L90-S1/025-M08		M8	7,0	10,0	19,0	8,5	16,0	10,0	13,0	200	~3,2 kg.	1.200	~19,2 kg.
SKP-L90-S1/025-M10		M10	7,0	10,0	19,0	10,5	18,0	12,0	15,0	150	~2,6 kg.	900	~15,6 kg.
SKP-L90-S1/025-M12		M12	7,0	10,0	19,0	13,0	19,0	13,0	18,0	150	~2,3 kg.	900	~13,8 kg.
SKP-L90-S1/035-M06	35	M6	8,5	12,0	23,0	6,5	17,0	7,5	11,0	125	~3,0 kg.	750	~18,0 kg.
SKP-L90-S1/035-M08		M8	8,5	12,0	23,0	8,5	17,0	10,0	13,0	100	~2,5 kg.	600	~15,0 kg.
SKP-L90-S1/035-M10		M10	8,5	12,0	23,0	10,5	19,0	12,0	15,0	100	~2,7 kg.	600	~16,2 kg.
SKP-L90-S1/035-M12		M12	8,5	12,0	23,0	13,0	21,0	13,0	18,0	100	~2,7 kg.	600	~16,2 kg.
SKP-L90-S1/050-M06	50	M6	10,0	14,0	25,0	6,5	20,0	10,0	13,0	80	~3,0 kg.	480	~18,0 kg.
SKP-L90-S1/050-M08		M8	10,0	14,0	25,0	8,5	20,0	10,0	13,0	80	~3,0 kg.	480	~18,0 kg.
SKP-L90-S1/050-M10		M10	10,0	14,0	25,0	10,5	20,0	12,0	16,0	70	~2,8 kg.	420	~16,8 kg.
SKP-L90-S1/050-M12		M12	10,0	14,0	25,0	13,0	23,0	13,0	18,0	70	~2,8 kg.	420	~16,8 kg.
SKP-L90-S1/070-M06	70	M6	12,0	16,5	29,0	6,5	23,0	10,0	13,0	50	~3,2 kg.	360	~19,2 kg.
SKP-L90-S1/070-M08		M8	12,0	16,5	29,0	8,5	23,0	10,0	14,0	50	~3,1 kg.	360	~18,6 kg.
SKP-L90-S1/070-M10		M10	12,0	16,5	29,0	10,5	23,0	12,0	16,0	50	~2,9 kg.	300	~17,4 kg.
SKP-L90-S1/070-M12		M12	12,0	16,5	29,0	13,0	23,0	13,0	18,0	50	~2,7 kg.	300	~16,2 kg.
SKP-L90-S1/095-M08	95	M8	13,5	18,0	33,0	8,5	26,0	12,0	14,0	40	~2,7 kg.	240	~16,2 kg.
SKP-L90-S1/095-M10		M10	13,5	18,0	33,0	10,5	26,0	12,0	17,0	40	~2,8 kg.	240	~16,8 kg.
SKP-L90-S1/095-M12		M12	13,5	18,0	33,0	13,0	26,0	13,0	18,0	40	~2,8 kg.	240	~16,8 kg.
SKP-L90-S1/095-M16		M16	13,5	18,0	33,0	17,0	28,0	16,0	22,0	35	~2,5 kg.	210	~15,0 kg.
SKP-L90-S1/120-M08	120	M8	15,0	19,5	36,0	8,5	28,0	14,0	16,0	30	~2,4 kg.	180	~14,4 kg.
SKP-L90-S1/120-M10		M10	15,0	19,5	36,0	10,5	28,0	14,0	17,0	30	~2,4 kg.	180	~14,4 kg.
SKP-L90-S1/120-M12		M12	15,0	19,5	36,0	13,0	28,0	14,0	18,0	30	~2,4 kg.	180	~14,4 kg.
SKP-L90-S1/120-M16		M16	15,0	19,5	36,0	17,0	30,0	16,0	22,0	25	~1,8 kg.	150	~10,8 kg.
SKP-L90-S1/150-M08	150	M8	16,5	21,0	40,0	8,5	31,0	14,0	16,0	25	~2,2 kg.	150	~13,2 kg.
SKP-L90-S1/150-M10		M10	16,5	21,0	40,0	10,5	31,0	14,0	17,0	25	~2,2 kg.	150	~13,2 kg.
SKP-L90-S1/150-M12		M12	16,5	21,0	40,0	13,0	31,0	15,0	18,0	25	~2,2 kg.	150	~13,2 kg.
SKP-L90-S1/150-M16		M16	16,5	21,0	40,0	17,0	31,0	16,0	22,0	20	~1,8 kg.	120	~10,8 kg.
SKP-L90-S1/150-M20	M20	16,5	21,0	40,0	21,0	36,0	22,0	24,0	20	~1,8 kg.	120	~10,8 kg.	

Order Code	Cable Section (mm <sup>2</sup> )	Bolt	Dimensions							Box Pcs.	Box Weight	Parcel Pcs.	Box Weight
			d1	d4	a	d2	b	c1	L3				
SKP-L90-S1/185-M10	185	M10	19,0	24,0	42,0	10,5	35,0	18,0	22,0	20	~3,0 kg.	120	~18,0 kg.
SKP-L90-S1/185-M12		M12	19,0	24,0	42,0	13,0	35,0	18,0	22,0	20	~2,9 kg.	120	~17,4 kg.
SKP-L90-S1/185-M16		M16	19,0	24,0	42,0	17,0	35,0	18,0	22,0	15	~2,8 kg.	90	~16,8 kg.
SKP-L90-S1/185-M20		M20	19,0	24,0	42,0	21,0	39,0	22,0	24,0	15	~2,8 kg.	90	~16,8 kg.
SKP-L90-S1/240-M10	240	M10	21,0	26,0	45,0	10,5	39,0	21,5	22,0	15	~2,4 kg.	90	~14,4 kg.
SKP-L90-S1/240-M12		M12	21,0	26,0	45,0	13,0	39,0	21,5	22,0	15	~2,4 kg.	90	~14,4 kg.
SKP-L90-S1/240-M16		M16	21,0	26,0	45,0	17,0	39,0	21,5	22,0	10	~1,6 kg.	60	~9,6 kg.
SKP-L90-S1/240-M20		M20	21,0	26,0	45,0	21,0	39,0	21,5	24,0	10	~1,6 kg.	60	~9,6 kg.
SKP-L90-S1/300-M12	300	M12	23,5	29,5	56,0	13,0	43,0	24,0	24,0	8	~1,9 kg.	48	~11,4 kg.
SKP-L90-S1/300-M16		M16	23,5	29,5	56,0	17,0	43,0	24,0	24,0	8	~1,8 kg.	48	~10,8 kg.
SKP-L90-S1/300-M20		M20	23,5	29,5	56,0	21,0	43,0	24,0	24,0	8	~1,8 kg.	48	~10,8 kg.
SKP-L90-S1/400-M12	400	M12	27,0	34,0	60,0	13,0	49,0	24,0	24,0	6	~2,0 kg.	36	~12,0 kg.
SKP-L90-S1/400-M16		M16	27,0	34,0	60,0	17,0	49,0	24,0	24,0	6	~1,9 kg.	36	~11,4 kg.
SKP-L90-S1/400-M20		M20	27,0	34,0	60,0	21,0	49,0	24,0	24,0	6	~1,9 kg.	36	~11,4 kg.
SKP-L90-S1/500-M12	500	M12	30,0	38,0	47,0	13,0	56,0	24,0	24,0	6	~2,7 kg.	36	~16,2 kg.
SKP-L90-S1/500-M16		M16	30,0	38,0	47,0	17,0	56,0	24,0	24,0	6	~2,7 kg.	36	~16,2 kg.
SKP-L90-S1/500-M20		M20	30,0	38,0	47,0	21,0	56,0	24,0	24,0	6	~2,7 kg.	36	~16,2 kg.

**SKP-L90-S1 SPECIFICATIONS**

MATERIAL	ELECTROLYTIC COPPER CONFORMED TO EN 13600
COATING	TIN PLATED
JOINT	CLAMP COUPLING
THICKNESS	VERY THICK
CABLE ENTRY	LONG



# SKP-L45-S1

EUROPE TYPE (S1) 45° ANGULAR CABLE LUGS

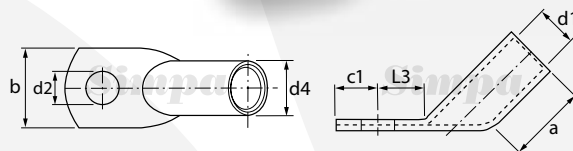

All rights reserved.

Order Code	Cable Section (mm <sup>2</sup> )	Bolt	Dimensions							Box Pcs.	Box Weight	Parcel Pcs.	Box Weight
			d1	d4	a	d2	b	c1	L3				
SKP-L45-S1/006-M05	6	M5	3,5	6,5	9,0	5,5	10,0	7,5	9,0	600	~3,6 kg.	3.600	~21,6 kg.
SKP-L45-S1/006-M06		M6	3,5	6,5	9,0	6,5	12,0	7,5	10,0	600	~3,7 kg.	3.600	~22,2 kg.
SKP-L45-S1/006-M08		M8	3,5	6,5	9,0	8,5	14,0	10,0	13,0	600	~3,8 kg.	3.600	~22,8 kg.
SKP-L45-S1/010-M05	10	M5	4,5	7,5	10,0	5,5	12,0	6,5	10,0	500	~2,4 kg.	3.000	~14,4 kg.
SKP-L45-S1/010-M06		M6	4,5	7,5	10,0	6,5	12,0	6,5	10,0	500	~2,8 kg.	3.000	~16,8 kg.
SKP-L45-S1/010-M08		M8	4,5	7,5	10,0	8,5	15,0	10,0	13,0	400	~3,6 kg.	2.400	~21,6 kg.
SKP-L45-S1/016-M05	16	M5	5,5	8,5	13,0	5,5	12,0	7,5	10,0	300	~3,1 kg.	1.800	~18,6 kg.
SKP-L45-S1/016-M06		M6	5,5	8,5	13,0	6,5	12,0	7,5	11,0	300	~3,1 kg.	1.800	~18,6 kg.
SKP-L45-S1/016-M08		M8	5,5	8,5	13,0	8,5	15,0	10,0	13,0	250	~2,9 kg.	1.500	~17,4 kg.
SKP-L45-S1/016-M10		M10	5,5	8,5	13,0	10,5	17,0	12,0	15,0	200	~3,2 kg.	1.200	~19,2 kg.
SKP-L45-S1/025-M05	25	M5	7,0	10,0	15,0	5,5	14,0	7,5	11,0	200	~3,9 kg.	1.200	~23,4 kg.
SKP-L45-S1/025-M06		M6	7,0	10,0	15,0	6,5	14,0	7,5	11,0	200	~2,8 kg.	1.200	~16,8 kg.
SKP-L45-S1/025-M08		M8	7,0	10,0	15,0	8,5	16,0	10,0	13,0	200	~3,0 kg.	1.200	~18,0 kg.
SKP-L45-S1/025-M10		M10	7,0	10,0	15,0	10,5	18,0	12,0	15,0	150	~2,5 kg.	900	~15,0 kg.
SKP-L45-S1/025-M12		M12	7,0	10,0	15,0	13,0	19,0	13,0	18,0	150	~2,5 kg.	900	~15,0 kg.
SKP-L45-S1/035-M06	35	M6	8,5	12,0	17,0	6,5	17,0	7,5	11,0	125	~3,0 kg.	750	~18,0 kg.
SKP-L45-S1/035-M08		M8	8,5	12,0	17,0	8,5	17,0	10,0	13,0	125	~3,0 kg.	750	~18,0 kg.
SKP-L45-S1/035-M10		M10	8,5	12,0	17,0	10,5	19,0	12,0	15,0	100	~2,5 kg.	600	~15,0 kg.
SKP-L45-S1/035-M12		M12	8,5	12,0	17,0	13,0	21,0	13,0	18,0	80	~2,4 kg.	480	~14,4 kg.
SKP-L45-S1/050-M06	50	M6	10,0	14,0	19,0	6,5	20,0	10,0	13,0	80	~2,9 kg.	480	~17,4 kg.
SKP-L45-S1/050-M08		M8	10,0	14,0	19,0	8,5	20,0	10,0	13,0	80	~2,9 kg.	480	~17,4 kg.
SKP-L45-S1/050-M10		M10	10,0	14,0	19,0	10,5	20,0	12,0	16,0	80	~3,0 kg.	480	~18,0 kg.
SKP-L45-S1/050-M12		M12	10,0	14,0	19,0	13,0	23,0	13,0	18,0	70	~3,0 kg.	420	~18,0 kg.
SKP-L45-S1/070-M06	70	M6	12,0	16,5	21,0	6,5	23,0	10,0	13,0	60	~3,2 kg.	360	~19,2 kg.
SKP-L45-S1/070-M08		M8	12,0	16,5	21,0	8,5	23,0	10,0	14,0	60	~3,0 kg.	360	~18,0 kg.
SKP-L45-S1/070-M10		M10	12,0	16,5	21,0	10,5	23,0	12,0	16,0	60	~3,2 kg.	360	~19,2 kg.
SKP-L45-S1/070-M12		M12	12,0	16,5	21,0	13,0	23,0	13,0	18,0	50	~2,7 kg.	300	~16,2 kg.
SKP-L45-S1/095-M08	95	M8	13,5	18,0	25,0	8,5	26,0	12,0	14,0	40	~2,5 kg.	240	~15,0 kg.
SKP-L45-S1/095-M10		M10	13,5	18,0	25,0	10,5	26,0	12,0	17,0	40	~2,6 kg.	240	~15,6 kg.
SKP-L45-S1/095-M12		M12	13,5	18,0	25,0	13,0	26,0	13,0	18,0	40	~2,8 kg.	240	~16,8 kg.
SKP-L45-S1/095-M16		M16	13,5	18,0	25,0	17,0	28,0	16,0	22,0	40	~2,8 kg.	240	~16,8 kg.
SKP-L45-S1/120-M08	120	M8	15,0	19,5	26,0	8,5	28,0	14,0	16,0	30	~2,3 kg.	180	~13,8 kg.
SKP-L45-S1/120-M10		M10	15,0	19,5	26,0	10,5	28,0	14,0	17,0	30	~2,3 kg.	180	~13,8 kg.
SKP-L45-S1/120-M12		M12	15,0	19,5	26,0	13,0	28,0	14,0	18,0	30	~2,3 kg.	180	~13,8 kg.
SKP-L45-S1/120-M16		M16	15,0	19,5	26,0	17,0	30,0	16,0	22,0	30	~2,2 kg.	180	~13,2 kg.
SKP-L45-S1/150-M08	150	M8	16,5	21,0	30,0	8,5	31,0	14,0	16,0	25	~2,4 kg.	150	~14,4 kg.
SKP-L45-S1/150-M10		M10	16,5	21,0	30,0	10,5	31,0	14,0	17,0	25	~2,2 kg.	150	~13,2 kg.
SKP-L45-S1/150-M12		M12	16,5	21,0	30,0	13,0	31,0	15,0	18,0	25	~2,4 kg.	150	~14,4 kg.
SKP-L45-S1/150-M16		M16	16,5	21,0	30,0	17,0	31,0	16,0	22,0	25	~2,3 kg.	150	~13,8 kg.
SKP-L45-S1/150-M20	M20	16,5	21,0	30,0	21,0	36,0	22,0	24,0	25	~2,2 kg.	150	~13,2 kg.	

Order Code	Cable Section (mm <sup>2</sup> )	Bolt	Dimensions							Box Pcs.	Box Weight	Parcel Pcs.	Box Weight
			d1	d4	a	d2	b	c1	L3				
SKP-L45-S1/185-M10	185	M10	19,0	24,0	30,0	10,5	35,0	18,0	22,0	20	~2,7 kg.	120	~16,2 kg.
SKP-L45-S1/185-M12		M12	19,0	24,0	30,0	13,0	35,0	18,0	22,0	20	~2,7 kg.	120	~16,2 kg.
SKP-L45-S1/185-M16		M16	19,0	24,0	30,0	17,0	35,0	18,0	22,0	20	~2,4 kg.	120	~14,4 kg.
SKP-L45-S1/185-M20		M20	19,0	24,0	30,0	21,0	39,0	22,0	24,0	20	~2,4 kg.	120	~14,4 kg.
SKP-L45-S1/240-M10	240	M10	21,0	26,0	35,0	10,5	39,0	21,5	22,0	15	~2,4 kg.	90	~14,4 kg.
SKP-L45-S1/240-M12		M12	21,0	26,0	35,0	13,0	39,0	21,5	22,0	15	~2,5 kg.	90	~15,0 kg.
SKP-L45-S1/240-M16		M16	21,0	26,0	35,0	17,0	39,0	21,5	22,0	15	~2,4 kg.	90	~14,4 kg.
SKP-L45-S1/240-M20		M20	21,0	26,0	35,0	21,0	39,0	21,5	24,0	15	~2,3 kg.	90	~13,8 kg.
SKP-L45-S1/300-M12	300	M12	23,5	29,5	44,0	13,0	43,0	24,0	24,0	8	~2,1 kg.	48	~12,6 kg.
SKP-L45-S1/300-M16		M16	23,5	29,5	44,0	17,0	43,0	24,0	24,0	8	~2,1 kg.	48	~12,6 kg.
SKP-L45-S1/300-M20		M20	23,5	29,5	44,0	21,0	43,0	24,0	24,0	8	~2,1 kg.	48	~12,6 kg.
SKP-L45-S1/400-M12	400	M12	27,0	34,0	44,0	13,0	49,0	24,0	24,0	6	~2,1 kg.	36	~12,6 kg.
SKP-L45-S1/400-M16		M16	27,0	34,0	44,0	17,0	49,0	24,0	24,0	6	~2,1 kg.	36	~12,6 kg.
SKP-L45-S1/400-M20		M20	27,0	34,0	44,0	21,0	49,0	24,0	24,0	6	~2,0 kg.	36	~12,0 kg.

**SKP-L45-S1 SPECIFICATIONS**

MATERIAL	ELECTROLYTIC COPPER CONFORMED TO EN 13600
COATING	TIN PLATED
JOINT	CLAMP COUPLING
THICKNESS	VERY THICK
CABLE ENTRY	LONG



# SKP-L90-D

DIN 46235 TYPE (D) 90° ANGULAR CABLE LUGS

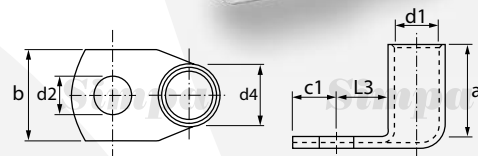

All rights reserved.

Order Code	Cable Section (mm <sup>2</sup> )	Bolt	Dimensions							Box Pcs,	Box Weight	Parcel Pcs,	Box Weight
			d1	d4	a	d2	b	c1	L3				
SKP-L90-D/006-M05	6	M5	3,8	5,5	10,0	5,3	8,5	6,5	9,0	500	~1,4 kg,	3000	~8,4 kg,
SKP-L90-D/006-M06		M6	3,8	5,5	10,0	6,4	8,5	7,5	10,0	500	~1,6 kg,	3000	~9,6 kg,
SKP-L90-D/010-M05	10	M5	4,5	6,0	10,0	5,3	9,0	7,0	10,0	300	~1,0 kg,	1800	~6,0 kg,
SKP-L90-D/010-M06		M6	4,5	6,0	10,0	6,4	9,0	7,5	10,0	300	~1,1 kg,	1800	~6,6 kg,
SKP-L90-D/010-M08		M8	4,5	6,0	10,0	7,0	13,0	10,0	13,0	300	~1,1 kg,	1800	~6,6 kg,
SKP-L90-D/016-M06	16	M6	5,5	8,5	20,0	6,4	13,0	7,5	11,0	125	~1,5 kg,	750	~9,0 kg,
SKP-L90-D/016-M08		M8	5,5	8,5	20,0	8,4	13,0	10,0	13,0	125	~1,6 kg,	750	~9,6 kg,
SKP-L90-D/016-M10		M10	5,5	8,5	20,0	10,5	17,0	12,0	15,0	125	~1,8 kg,	750	~10,8 kg,
SKP-L90-D/016-M12		M12	5,5	8,5	20,0	13,0	18,0	13,0	18,0	125	~1,7 kg,	750	~10,2 kg,
SKP-L90-D/025-M06	25	M6	7,0	10,0	20,0	6,4	14,0	7,5	11,0	100	~1,5 kg,	600	~9,0 kg,
SKP-L90-D/025-M08		M8	7,0	10,0	20,0	8,4	16,0	10,0	13,0	100	~1,6 kg,	600	~9,6 kg,
SKP-L90-D/025-M10		M10	7,0	10,0	20,0	10,5	17,0	12,0	15,0	100	~1,6 kg,	600	~9,6 kg,
SKP-L90-D/025-M12		M12	7,0	10,0	20,0	13,0	19,0	13,0	18,0	100	~1,7 kg,	600	~10,2 kg,
SKP-L90-D/035-M06	35	M6	8,2	12,5	20,0	8,4	17,0	10,0	13,0	80	~2,2 kg,	480	~13,2 kg,
SKP-L90-D/035-M08		M8	8,2	12,5	20,0	10,5	19,0	12,0	15,0	80	~2,2 kg,	480	~13,2 kg,
SKP-L90-D/035-M10		M10	8,2	12,5	20,0	13,0	21,0	13,0	18,0	80	~2,3 kg,	480	~13,8 kg,
SKP-L90-D/035-M12		M12	8,2	12,5	20,0	15,0	21,0	14,5	20,0	80	~2,3 kg,	480	~13,8 kg,
SKP-L90-D/050-M08	50	M8	10,0	14,5	28,0	8,4	20,0	10,0	16,0	60	~2,6 kg,	360	~15,6 kg,
SKP-L90-D/050-M10		M10	10,0	14,5	28,0	10,5	22,0	12,0	16,0	60	~2,7 kg,	360	~16,2 kg,
SKP-L90-D/050-M12		M12	10,0	14,5	28,0	13,0	24,0	13,0	18,0	60	~2,7 kg,	360	~16,2 kg,
SKP-L90-D/050-M14		M14	10,0	14,5	28,0	15,0	24,0	14,5	20,0	60	~2,8 kg,	360	~16,8 kg,
SKP-L90-D/050-M16	M16	10,0	14,5	28,0	17,0	28,0	16,0	22,0	60	~2,8 kg,	360	~16,8 kg,	
SKP-L90-D/070-M08	70	M8	11,5	16,5	28,0	8,4	24,0	10,0	14,0	50	~3,0 kg,	300	~18,0 kg,
SKP-L90-D/070-M10		M10	11,5	16,5	28,0	10,5	24,0	12,0	16,0	50	~3,2 kg,	300	~19,2 kg,
SKP-L90-D/070-M12		M12	11,5	16,5	28,0	13,0	24,0	13,0	18,0	50	~3,2 kg,	300	~19,2 kg,
SKP-L90-D/070-M14		M14	11,5	16,5	28,0	15,0	24,0	14,5	20,0	50	~3,3 kg,	300	~19,8 kg,
SKP-L90-D/070-M16	M16	11,5	16,5	28,0	17,0	30,0	16,0	22,0	50	~3,3 kg,	300	~19,8 kg,	
SKP-L90-D/095-M10	95	M10	13,5	19,0	35,0	10,5	28,0	12,0	17,0	25	~2,3 kg,	150	~13,8 kg,
SKP-L90-D/095-M12		M12	13,5	19,0	35,0	13,0	28,0	13,0	18,0	25	~2,3 kg,	150	~13,8 kg,
SKP-L90-D/095-M14		M14	13,5	19,0	35,0	15,0	28,0	14,5	20,0	25	~2,3 kg,	150	~13,8 kg,
SKP-L90-D/095-M16		M16	13,5	19,0	35,0	17,0	32,0	16,0	22,0	25	~2,3 kg,	150	~13,8 kg,
SKP-L90-D/120-M10	120	M10	15,5	21,0	35,0	10,5	32,0	15,0	17,0	25	~2,6 kg,	150	~15,6 kg,
SKP-L90-D/120-M12		M12	15,5	21,0	35,0	13,0	32,0	16,0	18,0	25	~2,7 kg,	150	~16,2 kg,
SKP-L90-D/120-M14		M14	15,5	21,0	35,0	15,0	32,0	18,0	20,0	25	~2,7 kg,	150	~16,2 kg,
SKP-L90-D/120-M16		M16	15,5	21,0	35,0	17,0	32,0	19,0	22,0	25	~2,7 kg,	150	~16,2 kg,
SKP-L90-D/120-M20	M20	15,5	21,0	35,0	21,0	38,0	21,0	24,0	25	~2,8 kg,	150	~16,8 kg,	
SKP-L90-D/150-M10	150	M10	17,0	23,5	35,0	10,5	34,0	15,0	17,0	15	~2,1 kg,	90	~12,6 kg,
SKP-L90-D/150-M12		M12	17,0	23,5	35,0	13,0	34,0	16,0	18,0	15	~2,1 kg,	90	~12,6 kg,
SKP-L90-D/150-M14		M14	17,0	23,5	35,0	15,0	34,0	19,0	20,0	15	~2,3 kg,	90	~13,8 kg,
SKP-L90-D/150-M16		M16	17,0	23,5	35,0	17,0	34,0	19,0	22,0	15	~2,3 kg,	90	~13,8 kg,
SKP-L90-D/150-M20		M20	17,0	23,5	35,0	21,0	40,0	21,0	24,0	15	~2,4 kg,	90	~14,4 kg,

Order Code	Cable Section (mm <sup>2</sup> )	Bolt	Dimensions							Box Pcs	Box Weight	Parcel Pcs	Box Weight
			d1	d4	a	d2	b	c1	L3				
SKP-L90-D/185-M10	<b>185</b>	M10	19,0	25,5	40,0	10,5	37,0	15,0	22,0	15	~2,8 kg.	90	~16,8 kg.
SKP-L90-D/185-M12		M12	19,0	25,5	40,0	13,0	37,0	16,0	22,0	15	~2,8 kg.	90	~16,8 kg.
SKP-L90-D/185-M14		M14	19,0	25,5	40,0	15,0	37,0	19,0	22,0	15	~2,9 kg.	90	~17,4 kg.
SKP-L90-D/185-M16		M16	19,0	25,5	40,0	17,0	37,0	19,0	22,0	15	~2,9 kg.	90	~17,4 kg.
SKP-L90-D/185-M20		M20	19,0	25,5	40,0	21,0	40,0	21,0	24,0	15	~2,8 kg.	90	~16,8 kg.
SKP-L90-D/240-M12	<b>240</b>	M12	21,5	29,0	40,0	13,0	42,0	16,0	22,0	8	~2,0 kg.	48	~12,0 kg.
SKP-L90-D/240-M14		M14	21,5	29,0	40,0	15,0	42,0	19,0	22,0	8	~2,1 kg.	48	~12,6 kg.
SKP-L90-D/240-M16		M16	21,5	29,0	40,0	17,0	42,0	19,0	22,0	8	~2,0 kg.	48	~12,0 kg.
SKP-L90-D/240-M20		M20	21,5	29,0	40,0	21,0	45,0	21,0	24,0	8	~2,0 kg.	48	~12,0 kg.

**SKP-L90-D SPECIFICATIONS**

MATERIAL	ELECTROLYTIC COPPER CONFORMED TO EN 13600
COATING	TIN PLATED
JOINT	CLAMP COUPLING
THICKNESS	VERY THICK
CABLE ENTRY	LONG
TUBE DIMENSIONS ACCORDING TO DIN 46235	



# SKP-L45-D

DIN 46235 TYPE (D) 45° ANGULAR CABLE LUGS

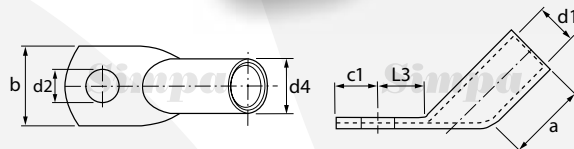

All rights reserved.

Order Code	Cable Section (mm <sup>2</sup> )	Bolt	Dimensions							Box Pcs	Box Weight	Parcel Pcs	Box Weight
			d1	d4	a	d2	b	c1	L3				
SKP-L45-D/006-M05	6	M5	3,8	5,5	10,0	5,5	8,5	6,5	9,0	500	~1,6 kg.	3000	~9,6 kg.
SKP-L45-D/006-M06		M6	3,8	5,5	10,0	6,5	8,5	7,5	10,0	500	~1,7 kg.	3000	~10,2 kg.
SKP-L45-D/010-M05	10	M5	4,5	6,0	10,0	5,5	9,0	7,0	10,0	300	~1,1 kg.	1800	~6,6 kg.
SKP-L45-D/010-M06		M6	4,5	6,0	10,0	6,5	9,0	7,5	10,0	300	~1,1 kg.	1800	~6,6 kg.
SKP-L45-D/010-M08		M8	4,5	6,0	10,0	8,5	13,0	10,0	13,0	300	~1,2 kg.	1800	~7,2 kg.
SKP-L45-D/016-M06	16	M6	5,5	8,5	20,0	6,5	13,0	7,5	11,0	125	~1,5 kg.	750	~9,0 kg.
SKP-L45-D/016-M08		M8	5,5	8,5	20,0	8,5	13,0	10,0	13,0	125	~1,6 kg.	750	~9,6 kg.
SKP-L45-D/016-M10		M10	5,5	8,5	20,0	10,5	17,0	12,0	15,0	125	~1,7 kg.	750	~10,2 kg.
SKP-L45-D/016-M12		M12	5,5	8,5	20,0	13,0	18,0	13,0	18,0	125	~1,7 kg.	750	~10,2 kg.
SKP-L45-D/025-M06	25	M6	7,0	10,0	20,0	6,5	14,0	7,5	11,0	100	~1,5 kg.	600	~9,0 kg.
SKP-L45-D/025-M08		M8	7,0	10,0	20,0	8,5	16,0	10,0	13,0	100	~1,6 kg.	600	~9,6 kg.
SKP-L45-D/025-M10		M10	7,0	10,0	20,0	10,5	17,0	12,0	15,0	100	~1,6 kg.	600	~9,6 kg.
SKP-L45-D/025-M12		M12	7,0	10,0	20,0	13,0	19,0	13,0	18,0	100	~1,7 kg.	600	~10,2 kg.
SKP-L45-D/035-M06	35	M6	8,2	12,5	20,0	8,5	17,0	10,0	13,0	80	~2,2 kg.	480	~13,2 kg.
SKP-L45-D/035-M08		M8	8,2	12,5	20,0	10,5	19,0	12,0	15,0	80	~2,3 kg.	480	~13,8 kg.
SKP-L45-D/035-M10		M10	8,2	12,5	20,0	13,0	21,0	13,0	18,0	80	~2,4 kg.	480	~14,4 kg.
SKP-L45-D/035-M12		M12	8,2	12,5	20,0	15,0	21,0	14,5	20,0	80	~2,4 kg.	480	~14,4 kg.
SKP-L45-D/050-M08	50	M8	10,0	14,5	28,0	8,5	20,0	10,0	13,0	60	~2,8 kg.	360	~16,8 kg.
SKP-L45-D/050-M10		M10	10,0	14,5	28,0	10,5	22,0	12,0	16,0	60	~2,9 kg.	360	~17,4 kg.
SKP-L45-D/050-M12		M12	10,0	14,5	28,0	13,0	24,0	13,0	18,0	60	~3,0 kg.	360	~18,0 kg.
SKP-L45-D/050-M14		M14	10,0	14,5	28,0	15,0	24,0	14,5	20,0	60	~3,0 kg.	360	~18,0 kg.
SKP-L45-D/050-M16		M16	10,0	14,5	28,0	17,0	28,0	16,0	22,0	60	~3,0 kg.	360	~18,0 kg.
SKP-L45-D/070-M08	70	M8	11,5	16,5	28,0	8,5	24,0	10,0	14,0	50	~3,2 kg.	300	~19,2 kg.
SKP-L45-D/070-M10		M10	11,5	16,5	28,0	10,5	24,0	12,0	16,0	50	~3,4 kg.	300	~20,4 kg.
SKP-L45-D/070-M12		M12	11,5	16,5	28,0	13,0	24,0	13,0	18,0	50	~3,5 kg.	300	~21,0 kg.
SKP-L45-D/070-M14		M14	11,5	16,5	28,0	15,0	24,0	14,5	20,0	50	~3,4 kg.	300	~20,4 kg.
SKP-L45-D/070-M16		M16	11,5	16,5	28,0	17,0	30,0	16,0	22,0	50	~3,5 kg.	300	~21,0 kg.
SKP-L45-D/095-M10	95	M10	13,5	19,0	35,0	10,5	28,0	12,0	17,0	25	~2,4 kg.	150	~14,4 kg.
SKP-L45-D/095-M12		M12	13,5	19,0	35,0	13,0	28,0	13,0	18,0	25	~2,3 kg.	150	~13,8 kg.
SKP-L45-D/095-M14		M14	13,5	19,0	35,0	15,0	28,0	14,5	20,0	25	~2,4 kg.	150	~14,4 kg.
SKP-L45-D/095-M16		M16	13,5	19,0	35,0	17,0	32,0	16,0	22,0	25	~2,4 kg.	150	~14,4 kg.
SKP-L45-D/120-M10	120	M10	15,5	21,0	35,0	10,5	32,0	15,0	17,0	25	~2,8 kg.	150	~16,8 kg.
SKP-L45-D/120-M12		M12	15,5	21,0	35,0	13,0	32,0	16,0	18,0	25	~2,9 kg.	150	~17,4 kg.
SKP-L45-D/120-M14		M14	15,5	21,0	35,0	15,0	32,0	18,0	20,0	25	~2,9 kg.	150	~17,4 kg.
SKP-L45-D/120-M16		M16	15,5	21,0	35,0	17,0	32,0	19,0	22,0	25	~2,9 kg.	150	~17,4 kg.
SKP-L45-D/120-M20		M20	15,5	21,0	35,0	21,0	38,0	21,0	24,0	25	~2,9 kg.	150	~17,4 kg.
SKP-L45-D/150-M10	150	M10	17,0	23,5	35,0	10,5	34,0	15,0	17,0	15	~2,4 kg.	90	~14,4 kg.
SKP-L45-D/150-M12		M12	17,0	23,5	35,0	13,0	34,0	16,0	18,0	15	~2,4 kg.	90	~14,4 kg.
SKP-L45-D/150-M14		M14	17,0	23,5	35,0	15,0	34,0	19,0	20,0	15	~2,5 kg.	90	~15,0 kg.
SKP-L45-D/150-M16		M16	17,0	23,5	35,0	17,0	34,0	19,0	22,0	15	~2,5 kg.	90	~15,0 kg.
SKP-L45-D/150-M20		M20	17,0	23,5	35,0	21,0	40,0	21,0	24,0	15	~2,5 kg.	90	~15,0 kg.

Order Code	Cable Section (mm <sup>2</sup> )	Bolt	Dimensions							Box Pcs	Box Weight	Parcel Pcs	Box Weight
			d1	d4	a	d2	b	c1	L3				
SKP-L45-D/185-M10	<b>185</b>	M10	19,0	25,5	40,0	10,5	37,0	15,0	22,0	15	~3,0 kg.	90	~18,0 kg.
SKP-L45-D/185-M12		M12	19,0	25,5	40,0	13,0	37,0	16,0	22,0	15	~2,9 kg.	90	~17,4 kg.
SKP-L45-D/185-M14		M14	19,0	25,5	40,0	15,0	37,0	19,0	22,0	15	~3,0 kg.	90	~18,0 kg.
SKP-L45-D/185-M16		M16	19,0	25,5	40,0	17,0	37,0	19,0	22,0	15	~3,0 kg.	90	~18,0 kg.
SKP-L45-D/185-M20		M20	19,0	25,5	40,0	21,0	40,0	21,0	24,0	15	~3,0 kg.	90	~18,0 kg.
SKP-L45-D/240-M12	<b>240</b>	M12	21,5	29,0	40,0	13,0	42,0	16,0	22,0	8	~2,1 kg.	48	~12,6 kg.
SKP-L45-D/240-M14		M14	21,5	29,0	40,0	15,0	42,0	19,0	22,0	8	~2,2 kg.	48	~13,2 kg.
SKP-L45-D/240-M16		M16	21,5	29,0	40,0	17,0	42,0	19,0	22,0	8	~2,2 kg.	48	~13,2 kg.
SKP-L45-D/240-M20		M20	21,5	29,0	40,0	21,0	45,0	21,0	24,0	8	~2,2 kg.	48	~13,2 kg.

**SKP-L45-D SPECIFICATIONS**

MATERIAL	ELECTROLYTIC COPPER CONFORMED TO EN 13600
COATING	TIN PLATED
JOINT	CLAMP COUPLING
THICKNESS	VERY THICK
CABLE ENTRY	LONG
TUBE DIMENSIONS ACCORDING TO DIN 46235	



# SKP-C

TUBULAR CABLE LUGS WITH TWO CONNECTION HOLES

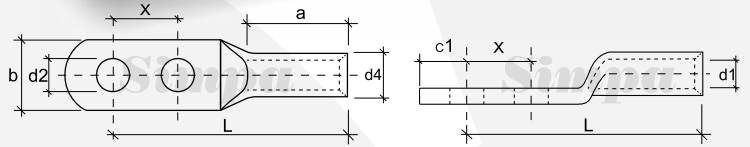

All rights reserved.

Order Code	Cable Section (mm <sup>2</sup> )	Bolt	Dimensions								Box Pcs.	Box Weight
			d1	d4	a	d2	b	C1	X	L		
SKP-C/016-M06/X16	16	M6	5,5	8,5	20,0	6,4	12,0	10,0	16,0	53,0	150	~2,3 kg.
SKP-C/016-M06/X25		M6	5,5	8,5	20,0	7,0	12,0	10,0	25,0	62,0	150	
SKP-C/025-M06/X16	25	M6	7,0	10,0	20,0	6,4	14,0	10,0	16,0	54,0	100	~2,1 kg.
SKP-C/025-M06/X25		M6	7,0	10,0	20,0	7,0	14,0	10,0	25,0	63,0	100	
SKP-C/025-M08/X16		M8	7,0	10,0	20,0	8,5	14,0	10,0	16,0	54,0	100	
SKP-C/025-M08/X25	35	M8	7,0	10,0	20,0	8,5	14,0	10,0	25,0	63,0	100	~2,9 kg.
SKP-C/035-M08/X16		M8	8,5	12,0	20,0	8,5	18,0	10,0	16,0	62,0	80	
SKP-C/035-M08/X25		M8	8,5	12,0	20,0	8,5	18,0	10,0	25,0	71,0	80	
SKP-C/035-M08/X40		M8	8,5	12,0	20,0	8,5	18,0	10,0	40,0	86,0	70	
SKP-C/035-M10/X25	50	M10	8,5	12,0	20,0	10,5	18,0	10,0	25,0	71,0	80	~2,8 kg.
SKP-C/035-M10/X40		M10	8,5	12,0	20,0	10,5	18,0	10,0	40,0	86,0	70	
SKP-C/050-M06/X25		M6	10,0	14,0	28,0	6,5	21,0	10,0	25,0	69,0	50	
SKP-C/050-M06/X40		M6	10,0	14,0	28,0	6,5	21,0	10,0	40,0	84,0	50	
SKP-C/050-M08/X25	70	M8	10,0	14,0	28,0	8,5	21,0	10,0	25,0	69,0	50	~3,2 kg.
SKP-C/050-M08/X40		M8	10,0	14,0	28,0	8,5	21,0	10,0	40,0	84,0	50	
SKP-C/050-M10/X25		M10	10,0	14,0	28,0	10,5	21,0	16,0	25,0	75,0	50	
SKP-C/050-M10/X40		M10	10,0	14,0	28,0	10,5	21,0	16,0	40,0	90,0	50	
SKP-C/050-M12/X25		M12	10,0	14,0	28,0	13,0	23,0	16,0	25,0	75,0	50	
SKP-C/050-M12/X40		M12	10,0	14,0	28,0	13,0	23,0	16,0	40,0	90,0	50	
SKP-C/070-M08/X25	95	M8	12,0	16,5	28,0	8,5	23,0	10,0	25,0	76,0	40	~2,4 kg.
SKP-C/070-M08/X40		M8	12,0	16,5	28,0	8,5	23,0	10,0	40,0	91,0	40	
SKP-C/070-M10/X25		M10	12,0	16,5	28,0	10,5	23,0	16,0	25,0	82,0	40	
SKP-C/070-M10/X40		M10	12,0	16,5	28,0	10,5	23,0	16,0	40,0	97,0	40	
SKP-C/070-M12/X25		M12	12,0	16,5	28,0	13,0	23,0	16,0	25,0	76,0	40	
SKP-C/070-M12/X40		M12	12,0	16,5	28,0	13,0	23,0	16,0	40,0	91,0	40	
SKP-C/070-M12/X45	120	M12	12,0	16,5	28,0	13,0	23,0	16,0	45,0	96,0	40	~2,6 kg.
SKP-C/070-M12/X60		M12	12,0	16,5	28,0	13,0	23,0	16,0	60,0	111,0	40	
SKP-C/095-M10/X25		M10	13,5	18,0	35,0	10,5	26,0	16,0	25,0	87,0	25	
SKP-C/095-M10/X40		M10	13,5	18,0	35,0	10,5	26,0	16,0	40,0	102,0	25	
SKP-C/095-M12/X25	120	M12	13,5	18,0	35,0	13,0	26,0	16,0	25,0	87,0	25	~3,1 kg.
SKP-C/095-M12/X40		M12	13,5	18,0	35,0	13,0	26,0	16,0	40,0	102,0	25	
SKP-C/095-M12/X45		M12	13,5	18,0	35,0	13,0	26,0	16,0	45,0	107,0	25	
SKP-C/095-M12/X60		M12	13,5	18,0	35,0	13,0	26,0	16,0	60,0	122,0	25	
SKP-C/120-M12/X25	120	M12	15,0	19,5	35,0	13,0	28,0	16,0	25,0	87,0	25	~2,6 kg.
SKP-C/120-M12/X40		M12	15,0	19,5	35,0	13,0	28,0	16,0	40,0	102,0	25	
SKP-C/120-M12/X45		M12	15,0	19,5	35,0	13,0	28,0	16,0	45,0	107,0	25	
SKP-C/120-M12/X60		M12	15,0	19,5	35,0	13,0	28,0	16,0	60,0	122,0	25	
SKP-C/120-M16/X40	120	M16	15,0	19,5	35,0	17,0	28,0	19,0	40,0	105,0	25	~2,6 kg.
SKP-C/120-M16/X50		M16	15,0	19,5	35,0	17,0	28,0	19,0	50,0	115,0	25	

Order Code	Cable Section (mm <sup>2</sup> )	Bolt	Dimensions								Box Pcs.	Box Weight
			d1	d4	a	d2	b	C1	X	L		
SKP-C/150-M12/X25	150	M12	16,5	21,0	35,0	13,0	31,0	16,0	25,0	90,0	20	~2,3 kg.
SKP-C/150-M12/X40		M12	16,5	21,0	35,0	13,0	31,0	16,0	40,0	105,0	20	
SKP-C/150-M12/X45		M12	16,5	21,0	35,0	13,0	31,0	16,0	45,0	110,0	20	
SKP-C/150-M12/X50		M12	16,5	21,0	35,0	13,0	31,0	16,0	50,0	115,0	20	~2,8 kg.
SKP-C/150-M12/X60		M12	16,5	21,0	35,0	13,0	31,0	16,0	60,0	125,0	20	
SKP-C/150-M16/X40		M16	16,5	21,0	35,0	17,0	31,0	19,0	40,0	108,0	20	
SKP-C/150-M16/X50	M16	16,5	21,0	35,0	17,0	31,0	19,0	50,0	118,0	20		
SKP-C/185-M12/X25	185	M12	19,0	24,0	40,0	13,0	35,0	16,0	25,0	96,0	12	~1,9 kg.
SKP-C/185-M12/X40		M12	19,0	24,0	40,0	13,0	35,0	16,0	40,0	111,0	12	~2,4 kg.
SKP-C/185-M12/X45		M12	19,0	24,0	40,0	13,0	35,0	16,0	45,0	116,0	12	
SKP-C/185-M12/X50		M12	19,0	24,0	40,0	13,0	35,0	16,0	50,0	121,0	12	
SKP-C/185-M12/X60		M12	19,0	24,0	40,0	13,0	35,0	16,0	60,0	131,0	12	
SKP-C/185-M16/X40		M16	19,0	24,0	40,0	17,0	35,0	19,0	40,0	114,0	12	
SKP-C/185-M16/X50	M16	19,0	24,0	40,0	17,0	35,0	19,0	50,0	124,0	12		
SKP-C/240-M12/X25	240	M12	21,0	26,0	40,0	13,0	38,0	16,0	25,0	97,0	12	~2,1 kg.
SKP-C/240-M12/X40		M12	21,0	26,0	40,0	13,0	38,0	16,0	40,0	112,0	12	
SKP-C/240-M12/X45		M12	21,0	26,0	40,0	13,0	38,0	16,0	45,0	117,0	12	
SKP-C/240-M12/X50		M12	21,0	26,0	40,0	13,0	38,0	16,0	50,0	122,0	12	
SKP-C/240-M12/X60		M12	21,0	26,0	40,0	13,0	38,0	16,0	60,0	132,0	12	
SKP-C/240-M16/X40		M16	21,0	26,0	40,0	17,0	38,0	19,0	40,0	115,0	12	
SKP-C/240-M16/X50	M16	21,0	26,0	40,0	17,0	38,0	19,0	50,0	125,0	12		

UPON REQUEST, IT IS AVAILABLE IN 45 & 95 DEGREES.



**SKP-C SPECIFICATIONS**

MATERIAL	ELECTROLYTIC COPPER CONFORMED TO EN 13600
COATING	TIN PLATED
JOINT	CLAMP COUPLING
THICKNESS	VERY THICK
CABLE ENTRY	LONG



# SEM-A

## STANDARD TYPE BUTT CONNECTORS

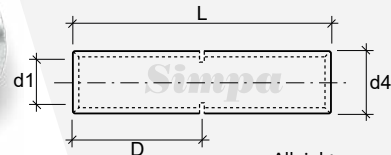

All rights reserved.

Order Code	Cable Section (mm <sup>2</sup> )	Dimensions				Box Pcs.	Box Weight	Parcel Pcs.	Box Weight
		d1	d4	L	D				
SEM-A/001.5	1.5	1.8	3.4	20.0	10.0	1.000	~1.1 kg.	8.000	~8.8 kg.
SEM-A/002.5	2.5	2.4	4.0	20.0	10.0	1.000	~1.3 kg.	8.000	~10.4 kg.
SEM-A/004	4	3.1	4.8	20.0	10.0	800	~1.4 kg.	6.400	~11.2 kg.
SEM-A/006	6	4.0	5.5	25.0	12.5	800	~2.1 kg.	6.400	~16.8 kg.
SEM-A/010	10	4.5	6.0	30.0	15.0	600	~2.1 kg.	4.800	~16.8 kg.
SEM-A/016	16	5.5	7.5	35.0	17.5	300	~2.0 kg.	2.400	~16.0 kg.
SEM-A/025	25	7.0	9.5	40.0	20.0	200	~2.4 kg.	1.600	~19.2 kg.
SEM-A/035	35	8.5	11.0	45.0	22.5	150	~2.2 kg.	1.200	~17.6 kg.
SEM-A/050	50	10.0	13.0	50.0	25.0	100	~2.4 kg.	1.000	~19.2 kg.
SEM-A/070	70	11.5	14.5	55.0	27.5	80	~2.4 kg.	640	~19.2 kg.
SEM-A/095	95	13.5	16.5	60.0	30.0	60	~2.3 kg.	480	~18.4 kg.
SEM-A/120	120	14.5	18.0	65.0	32.5	40	~2.1 kg.	320	~16.8 kg.
SEM-A/150	150	16.5	21.0	70.0	35.0	30	~2.6 kg.	240	~20.8 kg.
SEM-A/185	185	18.5	23.0	75.0	37.5	20	~2.0 kg.	160	~16.0 kg.
SEM-A/240	240	21.0	26.0	85.0	42.5	15	~2.1 kg.	120	~16.8 kg.
SEM-A/300	300	23.5	28.5	100.0	50.0	10	~1.9 kg.	80	~15.2 kg.
SEM-A/400	400	27.0	33.0	110.0	55.0	6	~1.5 kg.	48	~12.0 kg.
SEM-A/500	500	30.0	38.0	120.0	60.0	4	~1.7 kg.	32	~13.6 kg.
SEM-A/625	625	34.0	42.0	130.0	65.0	3	~1.7 kg.	24	~13.6 kg.

### SEM-A SPECIFICATIONS

MATERIAL	ELECTROLYTIC COPPER CONFORMED TO EN 13600
COATING	TIN PLATED
JOINT	CLAMP COUPLING
THICKNESS	THICK

# SEM-S1

## EUROPE TYPE BUTT CONNECTORS

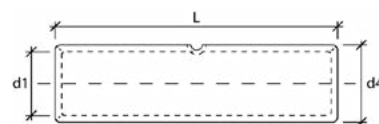

Order Code	Cable Section (mm <sup>2</sup> )	Dimensions			Box Pcs.	Box Weight	Parcel Pcs.	Box Weight
		d1	d4	L				
SEM-S1/002.5	2.5	2,3	4,2	25,0	700	~1,4 kg.	4200	~8,4 kg.
SEM-S1/004	4	3,0	5,0	25,0	600	~1,6 kg.	3600	~9,6 kg.
SEM-S1/006	6	3,5	6,5	25,0	600	~3,0 kg.	3600	~18,0 kg.
SEM-S1/010	10	4,5	7,0	30,0	400	~2,9 kg.	2400	~17,4 kg.
SEM-S1/016	16	5,5	8,5	35,0	300	~3,0 kg.	1800	~18,0 kg.
SEM-S1/025	25	7,0	10,0	40,0	200	~2,8 kg.	1200	~16,8 kg.
SEM-S1/035	35	8,5	12,0	45,0	125	~2,8 kg.	750	~16,8 kg.
SEM-S1/050	50	10,0	14,0	50,0	70	~2,4 kg.	420	~14,4 kg.
SEM-S1/070	70	12,0	16,5	55,0	60	~2,9 kg.	360	~17,4 kg.
SEM-S1/095	95	13,5	18,0	60,0	50	~3,0 kg.	300	~18,0 kg.
SEM-S1/120	120	15,0	19,5	65,0	40	~2,8 kg.	240	~16,8 kg.
SEM-S1/150	150	16,5	21,0	70,0	20	~1,6 kg.	120	~9,6 kg.
SEM-S1/185	185	19,0	24,0	75,0	20	~2,0 kg.	120	~12,0 kg.
SEM-S1/240	240	21,0	26,0	85,0	15	~2,1 kg.	90	~12,6 kg.
SEM-S1/300	300	23,5	29,5	100,0	10	~2,2 kg.	60	~13,2 kg.
SEM-S1/400	400	27,0	34,0	100,0	5	~1,5 kg.	30	~9,0 kg.

### SEM-S1 SPECIFICATIONS

MATERIAL	ELECTROLYTIC COPPER CONFORMED TO EN 13600
COATING	TIN PLATED
JOINT	CLAMP COUPLING
THICKNESS	VERY THICK



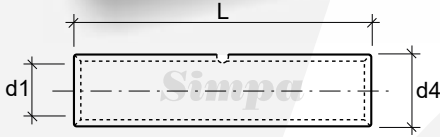

# SEM-D

## DIN 46267-1 TYPE BUTT CONNECTORS

All rights reserved.

Order Code	Cable Section (mm <sup>2</sup> )	Dimensions			Box Pcs.	Box Weight	Parcel Pcs.	Box Weight
		d1	d4	L				
SEM-D/006	<b>6</b>	3,8	5,5	30,0	700	~2,4 kg.	4200	~14,4 kg.
SEM-D/010	<b>10</b>	4,5	6,0	30,0	600	~1,9 kg.	3600	~11,4 kg.
SEM-D/016	<b>16</b>	5,5	8,5	50,0	200	~2,9 kg.	1200	~17,4 kg.
SEM-D/025	<b>25</b>	7,0	10,0	50,0	150	~2,7 kg.	900	~16,2 kg.
SEM-D/035	<b>35</b>	8,2	12,5	50,0	100	~3,9 kg.	600	~23,4 kg.
SEM-D/050	<b>50</b>	10,0	14,5	56,0	80	~3,4 kg.	480	~20,4 kg.
SEM-D/070	<b>70</b>	11,5	16,5	56,0	50	~2,7 kg.	300	~16,2 kg.
SEM-D/095	<b>95</b>	13,5	19,0	70,0	35	~3,1 kg.	210	~18,6 kg.
SEM-D/120	<b>120</b>	15,5	21,0	70,0	25	~2,4 kg.	150	~14,4 kg.
SEM-D/150	<b>150</b>	17,0	23,5	80,0	20	~2,9 kg.	120	~17,4 kg.
SEM-D/185	<b>185</b>	19,0	25,5	85,0	12	~2,1 kg.	72	~12,6 kg.
SEM-D/240	<b>240</b>	21,5	29,0	90,0	10	~2,4 kg.	60	~14,4 kg.
SEM-D/300	<b>300</b>	24,5	32,0	100,0	8	~2,4 kg.	48	~14,4 kg.
SEM-D/400	<b>400</b>	27,5	38,5	150,0	4	~3,0 kg.	24	~18,0 kg.
SEM-D/500	<b>500</b>	31,0	42,0	160,0	3	~2,7 kg.	18	~16,1 kg.
SEM-D/625	<b>625</b>	34,5	44,0	160,0	3	~2,4 kg.	18	~14,2 kg.
SEM-D/800	<b>800</b>	40,0	52,0	200,0	1	~1,5 kg.	6	
SEM-D/1000	<b>1000</b>	44,0	58,0	200,0	1	~2,0 kg.	6	

### SEM-D SPECIFICATIONS

MATERIAL	ELECTROLYTIC COPPER CONFORMED TO EN 13600
COATING	TIN PLATED
JOINT	CLAMP COUPLING
CONFORMED TO DIN 46267-1	



# SKP-F

## FORK TYPE CABLE LUGS

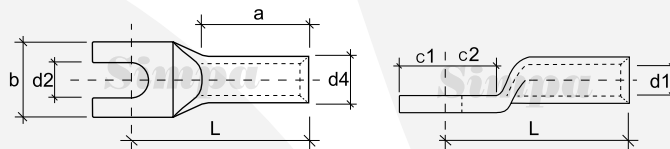

All rights reserved.

Order Code	Cable Section (mm <sup>2</sup> )	Bolt	Dimensions								Box Pcs.	Box Weight	Parcel Pcs.	Box Weight
			d1	d4	a	d2	b	c1	c2	L				
SKP-F/006-M04	6	M4	4,0	5,5	9,5	4,3	9,0	6,5	6,5	19,0	1.000	~2,3 kg.	8.000	~18,4 kg.
SKP-F/006-M05		M5	4,0	5,5	9,5	5,3	9,0	6,5	6,5	19,0	1.000	~2,2 kg.	8.000	~18,4 kg.
SKP-F/006-M06		M6	4,0	6,0	6,0	6,4	10,5	7,0	7,0	21,0	700	~2,4 kg.	5.600	~19,2 kg.
SKP-F/006-M08		M8	4,0	6,0	6,0	8,4	13,0	8,0	8,0	22,5	600	~2,2 kg.	4.800	~17,6 kg.
SKP-F/010-M05	10	M5	4,5	7,0	10,0	5,3	12,0	6,5	7,5	22,0	500	~2,1 kg.	4.000	~16,8 kg.
SKP-F/010-M06		M6	4,5	7,0	10,0	6,4	12,0	6,5	7,5	22,0	500	~2,1 kg.	4.000	~16,8 kg.
SKP-F/010-M08		M8	4,5	7,5	10,0	8,4	15,0	10,0	10,0	25,0	400	~2,4 kg.	3.200	~19,2 kg.
SKP-F/016-M05	16	M5	5,5	8,5	13,0	5,4	12,0	5,5	6,5	26,0	400	~2,2 kg.	2.400	~13,2 kg.
SKP-F/016-M06		M6	5,5	8,5	13,0	6,4	12,0	6,2	7,5	27,0	400	~3,4 kg.	2.400	~20,4 kg.
SKP-F/016-M08		M8	5,5	8,5	13,0	8,4	15,0	8,5	9,5	29,0	300	~2,8 kg.	1.800	~16,8 kg.

### SKP-F SPECIFICATIONS

MATERIAL	ELECTROLYTIC COPPER CONFORMED TO EN 13800
COATING	TIN PLATED
JOINT	CLAMP COUPLING
CABLE ENTRY	STANDARD





# AKP-D

DIN 46329 TYPE ALUMINIUM CABLE LUGS

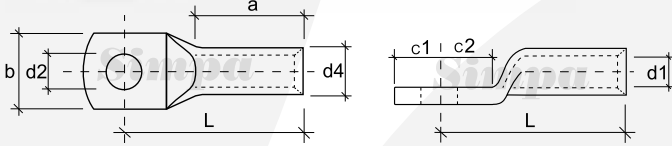

All rights reserved.

Order Code	Cable Section (mm <sup>2</sup> )	Bolt	Dimensions									Box Pcs.	Box Weight	Parcel Pcs.	Box Weight
			d1	d4	a	d2	b	c1	c2	L	L+c1				
<b>AKP-D/010-M08/SD</b>	<b>10</b>	<b>M8</b>	<b>5.0</b>	<b>10.0</b>	<b>32.0</b>	<b>8.5</b>	<b>18.0</b>	<b>10.0</b>	<b>11.5</b>	<b>52.0</b>	<b>62.0</b>	<b>125</b>	<b>~1.3 kg.</b>	<b>1 250</b>	<b>~13.0 kg.</b>
<b>AKP-D/016-M08/SD</b>	<b>16</b>	<b>M8</b>	<b>5.8</b>	<b>12.0</b>	<b>34.0</b>	<b>8.5</b>	<b>18.0</b>	<b>10.0</b>	<b>11.5</b>	<b>52.0</b>	<b>62.0</b>	<b>100</b>	<b>~1.3 kg.</b>	<b>1 000</b>	<b>~13.0 kg.</b>
AKP-D/016-M10		M10	5.8	12.0	34.0	10.5	18.0	10.0	11.5	52.0	62.0	100	~1.3 kg.	1 000	~13.0 kg.
<b>AKP-D/025-M08/SD</b>	<b>25</b>	<b>M8</b>	<b>6.8</b>	<b>12.0</b>	<b>40.0</b>	<b>8.5</b>	<b>18.0</b>	<b>10.0</b>	<b>11.5</b>	<b>60.0</b>	<b>70.0</b>	<b>80</b>	<b>~1.1 kg.</b>	<b>800</b>	<b>~11.0 kg.</b>
AKP-D/025-M10		M10	6.8	12.0	40.0	10.5	19.0	12.0	12.0	60.0	72.0	80	~1.1 kg.	800	~11.0 kg.
AKP-D/025-M12		M12	6.8	12.0	40.0	13.0	21.0	13.0	13.0	60.0	73.0	80	~1.1 kg.	800	~11.0 kg.
AKP-D/035-M08		M8	8.0	14.0	43.0	8.5	21.0	11.5	14.0	67.0	78.5	60	~1.3 kg.	600	~13.0 kg.
<b>AKP-D/035-M10/SD</b>	<b>35</b>	<b>M10</b>	<b>8.0</b>	<b>14.0</b>	<b>43.0</b>	<b>10.5</b>	<b>21.0</b>	<b>11.5</b>	<b>14.0</b>	<b>67.0</b>	<b>78.5</b>	<b>60</b>	<b>~1.3 kg.</b>	<b>600</b>	<b>~13.0 kg.</b>
AKP-D/035-M12		M12	8.0	14.0	43.0	13.0	21.0	11.5	14.0	67.0	78.5	60	~1.2 kg.	600	~12.0 kg.
AKP-D/035-M14		M14	8.0	14.0	43.0	15.0	21.0	12.0	16.0	69.0	81.0	60	~1.3 kg.	600	~13.0 kg.
<b>AKP-D/050-M10/SD</b>	<b>50</b>	<b>M10</b>	<b>9.8</b>	<b>16.0</b>	<b>46.0</b>	<b>10.5</b>	<b>25.0</b>	<b>14.0</b>	<b>15.0</b>	<b>72.0</b>	<b>86.0</b>	<b>40</b>	<b>~1.1 kg.</b>	<b>400</b>	<b>~11.0 kg.</b>
AKP-D/050-M12		M12	9.8	16.0	46.0	13.0	25.0	14.0	15.0	72.0	86.0	40	~1.1 kg.	400	~11.0 kg.
<b>AKP-D/070-M10/SD</b>	<b>70</b>	<b>M10</b>	<b>11.2</b>	<b>18.5</b>	<b>54.0</b>	<b>10.5</b>	<b>28.0</b>	<b>15.0</b>	<b>17.5</b>	<b>86.0</b>	<b>101.0</b>	<b>25</b>	<b>~1.4 kg.</b>	<b>250</b>	<b>~14.0 kg.</b>
AKP-D/070-M12		M12	11.2	18.5	54.0	13.0	28.0	15.0	17.5	86.0	101.0	25	~1.1 kg.	250	~11.0 kg.
AKP-D/095-M10		M10	13.2	22.0	59.0	10.5	32.0	15.5	17.5	90.0	105.5	15	~1.0 kg.	150	~10.0 kg.
<b>AKP-D/095-M12/SD</b>	<b>95</b>	<b>M12</b>	<b>13.2</b>	<b>22.0</b>	<b>59.0</b>	<b>13.0</b>	<b>32.0</b>	<b>15.5</b>	<b>17.5</b>	<b>90.0</b>	<b>105.5</b>	<b>15</b>	<b>~1.0 kg.</b>	<b>150</b>	<b>~10.0 kg.</b>
AKP-D/095-M16		M16	13.2	22.0	59.0	17.0	34.0	15.5	17.5	90.0	105.5	15	~1.0 kg.	150	~10.0 kg.
<b>AKP-D/120-M12/SD</b>	<b>120</b>	<b>M12</b>	<b>14.7</b>	<b>23.0</b>	<b>59.0</b>	<b>13.0</b>	<b>32.0</b>	<b>16.0</b>	<b>17.5</b>	<b>91.0</b>	<b>107.0</b>	<b>15</b>	<b>~1.0 kg.</b>	<b>150</b>	<b>~10.0 kg.</b>
AKP-D/120-M16		M16	14.7	23.0	59.0	17.0	34.0	16.0	17.5	91.0	107.0	15	~1.3 kg.	150	~13.0 kg.
<b>AKP-D/150-M12/SD</b>	<b>150</b>	<b>M12</b>	<b>16.3</b>	<b>25.0</b>	<b>62.0</b>	<b>13.0</b>	<b>35.0</b>	<b>17.5</b>	<b>20.0</b>	<b>103.0</b>	<b>120.5</b>	<b>12</b>	<b>~1.1 kg.</b>	<b>120</b>	<b>~11.0 kg.</b>
AKP-D/150-M16		M16	16.3	25.0	62.0	17.0	35.0	17.5	20.0	103.0	120.5	12	~1.1 kg.	120	~11.0 kg.
AKP-D/150-M20		M20	16.3	25.0	62.0	21.0	41.0	17.5	20.0	103.0	120.5	12	~1.1 kg.	120	~11.0 kg.
AKP-D/185-M12		M12	18.3	28.5	63.0	13.0	40.0	19.0	20.0	106.0	125.0	8	~1.0 kg.	80	~10.0 kg.
<b>AKP-D/185-M16/SD</b>	<b>185</b>	<b>M16</b>	<b>18.3</b>	<b>28.5</b>	<b>63.0</b>	<b>17.0</b>	<b>40.0</b>	<b>19.0</b>	<b>20.0</b>	<b>106.0</b>	<b>125.0</b>	<b>8</b>	<b>~1.0 kg.</b>	<b>80</b>	<b>~10.0 kg.</b>
AKP-D/185-M20		M20	18.3	28.5	63.0	21.0	40.0	19.0	20.0	106.0	125.0	8	~1.1 kg.	80	~11.0 kg.
AKP-D/240-M12		M12	21.0	32.0	72.0	13.0	45.0	23.0	24.0	116.0	139.0	8	~1.4 kg.	80	~14.0 kg.
<b>AKP-D/240-M16/SD</b>	<b>240</b>	<b>M16</b>	<b>21.0</b>	<b>32.0</b>	<b>72.0</b>	<b>17.0</b>	<b>45.0</b>	<b>23.0</b>	<b>24.0</b>	<b>116.0</b>	<b>139.0</b>	<b>8</b>	<b>~1.4 kg.</b>	<b>80</b>	<b>~14.0 kg.</b>
AKP-D/240-M20		M20	21.0	32.0	72.0	21.0	45.0	23.0	24.0	116.0	139.0	8	~1.4 kg.	80	~14.0 kg.
<b>AKP-D/300-M16/SD</b>	<b>300</b>	<b>M16</b>	<b>23.3</b>	<b>34.0</b>	<b>74.0</b>	<b>17.0</b>	<b>49.0</b>	<b>24.0</b>	<b>25.0</b>	<b>124.0</b>	<b>148.0</b>	<b>5</b>	<b>~1.0 kg.</b>	<b>50</b>	<b>~10.0 kg.</b>
AKP-D/300-M20		M20	23.3	34.0	74.0	21.0	49.0	24.0	25.0	124.0	148.0	5	~1.0 kg.	50	~10.0 kg.
<b>AKP-D/400-M16/SD</b>	<b>400</b>	<b>M16</b>	<b>26.0</b>	<b>38.5</b>	<b>105.0</b>	<b>17.0</b>	<b>58.0</b>	<b>30.0</b>	<b>32.0</b>	<b>166.0</b>	<b>196.0</b>	<b>10</b>	<b>~3.3 kg.</b>	<b>20</b>	<b>~33.0 kg.</b>
AKP-D/400-M20		M20	26.0	38.5	105.0	21.0	58.0	30.0	32.0	166.0	196.0	10	~3.3 kg.	20	~33.0 kg.

**AKP-D SPECIFICATIONS**

MATERIAL	ELECTROLYTIC ALUMINIUM
COATING	NATURAL BRIGHT
JOINT	CLAMP COUPLING
CONFORMED TO DIN 46329 TUBE DIMENSIONS	

THE CABLE LUGS WHICH ARE INDICATED IN BOLD FONT, ARE STANDARD PRODUCTS OF **Simpa**



# AKP-DY

ALUMINIUM CABLE LUGS  
WITH OXIDE PROTECTION OIL DIN 46329

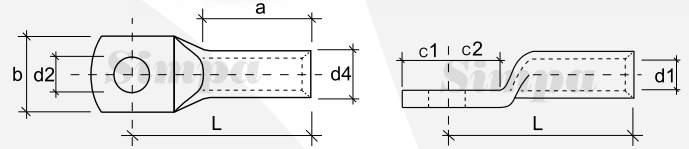

All rights reserved.

Order Code	Cable Section (mm <sup>2</sup> )	Bolt	Dimensions									Box Pcs.	Box Weight	Parcel Pcs.	Box Weight
			d1	d4	a	d2	b	c1	c2	L	L+c1				
<b>AKP-DY/016-M08/SD</b>	<b>16</b>	<b>M8</b>	<b>5.8</b>	<b>12.0</b>	<b>34.0</b>	<b>8.5</b>	<b>18.0</b>	<b>10.0</b>	<b>11.5</b>	<b>52.0</b>	<b>62.0</b>	<b>100</b>	<b>~1.3</b> kg.	<b>1.000</b>	<b>~13.0</b> kg.
AKP-DY/016-M10		M10	5.8	12.0	34.0	10.5	18.0	10.0	11.5	52.0	62.0	100	~1.3	1.000	~13.0
<b>AKP-DY/025-M08/SD</b>	<b>25</b>	<b>M8</b>	<b>6.8</b>	<b>12.0</b>	<b>40.0</b>	<b>8.5</b>	<b>18.0</b>	<b>10.0</b>	<b>11.5</b>	<b>60.0</b>	<b>70.0</b>	<b>80</b>	<b>~1.1</b> kg.	<b>800</b>	<b>~11.0</b> kg.
AKP-DY/025-M10		M10	6.8	12.0	40.0	10.5	19.0	12.0	12.0	60.0	72.0	80	~1.1	800	~11.0
AKP-DY/025-M12		M12	6.8	12.0	40.0	13.0	21.0	13.0	13.0	60.0	73.0	80	~1.1	800	~11.0
AKP-DY/035-M08	<b>35</b>	<b>M8</b>	<b>8.0</b>	<b>14.0</b>	<b>43.0</b>	<b>8.5</b>	<b>21.0</b>	<b>11.5</b>	<b>14.0</b>	<b>67.0</b>	<b>78.5</b>	<b>60</b>	<b>~1.3</b> kg.	<b>600</b>	<b>~13.0</b> kg.
<b>AKP-DY/035-M10/SD</b>		<b>M10</b>	<b>8.0</b>	<b>14.0</b>	<b>43.0</b>	<b>10.5</b>	<b>21.0</b>	<b>11.5</b>	<b>14.0</b>	<b>67.0</b>	<b>78.5</b>	<b>60</b>	<b>~1.3</b> kg.	<b>600</b>	<b>~13.0</b> kg.
AKP-DY/035-M12		M12	8.0	14.0	43.0	13.0	21.0	11.5	14.0	67.0	78.5	60	~1.3	600	~13.0
<b>AKP-DY/050-M10/SD</b>	<b>50</b>	<b>M10</b>	<b>9.8</b>	<b>16.0</b>	<b>46.0</b>	<b>10.5</b>	<b>25.0</b>	<b>14.0</b>	<b>15.0</b>	<b>72.0</b>	<b>86.0</b>	<b>40</b>	<b>~1.4</b> kg.	<b>400</b>	<b>~14.0</b> kg.
AKP-DY/050-M12		M12	9.8	16.0	46.0	13.0	25.0	14.0	15.0	72.0	86.0	40	~1.4	400	~14.0
<b>AKP-DY/070-M10/SD</b>	<b>70</b>	<b>M10</b>	<b>11.2</b>	<b>18.5</b>	<b>54.0</b>	<b>10.5</b>	<b>28.0</b>	<b>15.0</b>	<b>17.5</b>	<b>86.0</b>	<b>101.0</b>	<b>25</b>	<b>~1.4</b> kg.	<b>250</b>	<b>~14.0</b> kg.
AKP-DY/070-M12		M12	11.2	18.5	54.0	13.0	28.0	15.0	17.5	86.0	101.0	25	~1.4	250	~14.0
AKP-DY/095-M10	<b>95</b>	<b>M10</b>	<b>13.2</b>	<b>22.0</b>	<b>59.0</b>	<b>10.5</b>	<b>32.0</b>	<b>15.5</b>	<b>17.5</b>	<b>90.0</b>	<b>105.5</b>	<b>15</b>	<b>~1.0</b> kg.	<b>150</b>	<b>~10.0</b> kg.
<b>AKP-DY/095-M12/SD</b>		<b>M12</b>	<b>13.2</b>	<b>22.0</b>	<b>59.0</b>	<b>13.0</b>	<b>32.0</b>	<b>15.5</b>	<b>17.5</b>	<b>90.0</b>	<b>105.5</b>	<b>15</b>	<b>~1.0</b> kg.	<b>150</b>	<b>~10.0</b> kg.
AKP-DY/095-M16		M16	13.2	22.0	59.0	17.0	34.0	15.5	17.5	90.0	105.5	15	~1.0	150	~10.0
<b>AKP-DY/120-M12/SD</b>	<b>120</b>	<b>M12</b>	<b>14.7</b>	<b>23.0</b>	<b>59.0</b>	<b>13.0</b>	<b>32.0</b>	<b>16.0</b>	<b>17.5</b>	<b>91.0</b>	<b>107.0</b>	<b>15</b>	<b>~0.9</b> kg.	<b>150</b>	<b>~9.0</b> kg.
AKP-DY/120-M16		M16	14.7	23.0	59.0	17.0	34.0	16.0	17.5	91.0	107.0	15	~0.9	150	~9.0
<b>AKP-DY/150-M12/SD</b>	<b>150</b>	<b>M12</b>	<b>16.3</b>	<b>25.0</b>	<b>62.0</b>	<b>13.0</b>	<b>35.0</b>	<b>17.5</b>	<b>20.0</b>	<b>103.0</b>	<b>120.5</b>	<b>12</b>	<b>~1.1</b> kg.	<b>120</b>	<b>~11.0</b> kg.
AKP-DY/150-M16		M16	16.3	25.0	62.0	17.0	35.0	17.5	20.0	103.0	120.5	12	~1.1	120	~11.0
AKP-DY/150-M20		M20	16.3	25.0	62.0	21.0	41.0	17.5	20.0	103.0	120.5	12	~1.1	120	~11.0
AKP-DY/185-M12	<b>185</b>	<b>M12</b>	<b>18.3</b>	<b>28.5</b>	<b>63.0</b>	<b>13.0</b>	<b>40.0</b>	<b>19.0</b>	<b>20.0</b>	<b>106.0</b>	<b>125.0</b>	<b>8</b>	<b>~1.1</b> kg.	<b>80</b>	<b>~11.0</b> kg.
<b>AKP-DY/185-M16/SD</b>		<b>M16</b>	<b>18.3</b>	<b>28.5</b>	<b>63.0</b>	<b>17.0</b>	<b>40.0</b>	<b>19.0</b>	<b>20.0</b>	<b>106.0</b>	<b>125.0</b>	<b>8</b>	<b>~1.1</b> kg.	<b>80</b>	<b>~11.0</b> kg.
AKP-DY/185-M20		M20	18.3	28.5	63.0	21.0	40.0	19.0	20.0	106.0	125.0	8	~1.1	80	~11.0
AKP-DY/240-M12	<b>240</b>	<b>M12</b>	<b>21.0</b>	<b>32.0</b>	<b>72.0</b>	<b>13.0</b>	<b>45.0</b>	<b>23.0</b>	<b>24.0</b>	<b>116.0</b>	<b>139.0</b>	<b>8</b>	<b>~1.4</b> kg.	<b>80</b>	<b>~14.0</b> kg.
<b>AKP-DY/240-M16/SD</b>		<b>M16</b>	<b>21.0</b>	<b>32.0</b>	<b>72.0</b>	<b>17.0</b>	<b>45.0</b>	<b>23.0</b>	<b>24.0</b>	<b>116.0</b>	<b>139.0</b>	<b>8</b>	<b>~1.4</b> kg.	<b>80</b>	<b>~14.0</b> kg.
AKP-DY/240-M20		M20	21.0	32.0	72.0	21.0	45.0	23.0	24.0	116.0	139.0	8	~1.4	80	~14.0
<b>AKP-DY/300-M16/SD</b>	<b>300</b>	<b>M16</b>	<b>23.3</b>	<b>34.0</b>	<b>74.0</b>	<b>17.0</b>	<b>49.0</b>	<b>24.0</b>	<b>25.0</b>	<b>124.0</b>	<b>148.0</b>	<b>5</b>	<b>~1.2</b> kg.	<b>50</b>	<b>~12.0</b> kg.
AKP-DY/300-M20		M20	23.3	34.0	74.0	21.0	49.0	24.0	25.0	124.0	148.0	5	~1.2	50	~12.0
<b>AKP-DY/400-M16/SD</b>	<b>400</b>	<b>M16</b>	<b>26.0</b>	<b>38.5</b>	<b>105.0</b>	<b>17.0</b>	<b>58.0</b>	<b>30.0</b>	<b>32.0</b>	<b>166.0</b>	<b>196.0</b>	<b>10</b>	<b>~3.3</b> kg.	<b>20</b>	<b>~33.0</b> kg.
AKP-DY/400-M20		M20	26.0	38.5	105.0	21.0	58.0	30.0	32.0	166.0	196.0	10	~3.3	20	~33.0

## AKP-DY SPECIFICATIONS

MATERIAL	ELECTROLYTIC ALUMINIUM
COATING	NATURAL BRIGHT
JOINT	CLAMP COUPLING
CONFORMED TO DIN 46329 TUBE DIMENSIONS	

THE CABLE LUGS WHICH ARE INDICATED IN BOLD FONT, ARE STANDARD PRODUCTS OF **Simpa**





# AKP-DK

ALUMINIUM CABLE LUGS TIN PLATED  
WITH OXIDE PROTECTION OIL DIN 46329

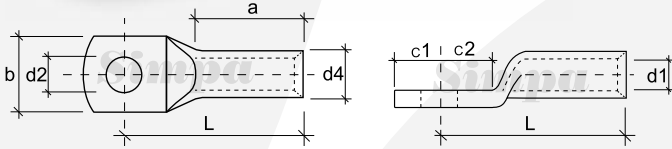

All rights reserved.

Order Code	Cable Section (mm <sup>2</sup> )	Bolt	Dimensions									Box Pcs.	Box Weight	Parcel Pcs.	Box Weight
			d1	d4	a	d2	b	c1	c2	L	L+c1				
<b>AKP-DK/016-M08/SD</b>	<b>16</b>	<b>M8</b>	<b>5.8</b>	<b>12.0</b>	<b>34.0</b>	<b>8.5</b>	<b>18.0</b>	<b>10.0</b>	<b>11.5</b>	<b>52.0</b>	<b>62.0</b>	<b>100</b>	<b>~1.3</b> kg.	<b>1 000</b>	<b>~13.0</b> kg.
AKP-DK/016-M10		M10	5.8	12.0	34.0	10.5	18.0	10.0	11.5	52.0	62.0	100	~1.3	1 000	~13.0
<b>AKP-DK/025-M08/SD</b>	<b>25</b>	<b>M8</b>	<b>6.8</b>	<b>12.0</b>	<b>40.0</b>	<b>8.5</b>	<b>18.0</b>	<b>10.0</b>	<b>11.5</b>	<b>60.0</b>	<b>70.0</b>	<b>80</b>	<b>~1.1</b> kg.	<b>800</b>	<b>~11.0</b> kg.
AKP-DK/025-M10		M10	6.8	12.0	40.0	10.5	19.0	12.0	12.0	60.0	72.0	80	~1.1	800	~11.0
AKP-DK/025-M12		M12	6.8	12.0	40.0	13.0	21.0	13.0	13.0	60.0	73.0	80	~1.1	800	~11.0
<b>AKP-DK/035-M08</b>	<b>35</b>	<b>M8</b>	<b>8.0</b>	<b>14.0</b>	<b>43.0</b>	<b>8.5</b>	<b>21.0</b>	<b>11.5</b>	<b>14.0</b>	<b>67.0</b>	<b>78.5</b>	<b>60</b>	<b>~1.3</b> kg.	<b>600</b>	<b>~13.0</b> kg.
<b>AKP-DK/035-M10/SD</b>		<b>M10</b>	<b>8.0</b>	<b>14.0</b>	<b>43.0</b>	<b>10.5</b>	<b>21.0</b>	<b>11.5</b>	<b>14.0</b>	<b>67.0</b>	<b>78.5</b>	<b>60</b>	<b>~1.3</b> kg.	<b>600</b>	<b>~13.0</b> kg.
AKP-DK/035-M12		M12	8.0	14.0	43.0	13.0	21.0	11.5	14.0	67.0	78.5	60	~1.3	600	~13.0
<b>AKP-DK/050-M10/SD</b>	<b>50</b>	<b>M10</b>	<b>9.8</b>	<b>16.0</b>	<b>46.0</b>	<b>10.5</b>	<b>25.0</b>	<b>14.0</b>	<b>15.0</b>	<b>72.0</b>	<b>86.0</b>	<b>40</b>	<b>~1.4</b> kg.	<b>400</b>	<b>~14.0</b> kg.
AKP-DK/050-M12		M12	9.8	16.0	46.0	13.0	25.0	14.0	15.0	72.0	86.0	40	~1.4	400	~14.0
<b>AKP-DK/070-M10/SD</b>	<b>70</b>	<b>M10</b>	<b>11.2</b>	<b>18.5</b>	<b>54.0</b>	<b>10.5</b>	<b>28.0</b>	<b>15.0</b>	<b>17.5</b>	<b>86.0</b>	<b>101.0</b>	<b>25</b>	<b>~1.4</b> kg.	<b>250</b>	<b>~14.0</b> kg.
AKP-DK/070-M12		M12	11.2	18.5	54.0	13.0	28.0	15.0	17.5	86.0	101.0	25	~1.4	250	~14.0
<b>AKP-DK/095-M10</b>	<b>95</b>	<b>M10</b>	<b>13.2</b>	<b>22.0</b>	<b>59.0</b>	<b>10.5</b>	<b>32.0</b>	<b>15.5</b>	<b>17.5</b>	<b>90.0</b>	<b>105.5</b>	<b>15</b>	<b>~1.0</b> kg.	<b>150</b>	<b>~10.0</b> kg.
<b>AKP-DK/095-M12/SD</b>		<b>M12</b>	<b>13.2</b>	<b>22.0</b>	<b>59.0</b>	<b>13.0</b>	<b>32.0</b>	<b>15.5</b>	<b>17.5</b>	<b>90.0</b>	<b>105.5</b>	<b>15</b>	<b>~1.0</b> kg.	<b>150</b>	<b>~10.0</b> kg.
AKP-DK/095-M16		M16	13.2	22.0	59.0	17.0	34.0	15.5	17.5	90.0	105.5	15	~1.0	150	~10.0
<b>AKP-DK/120-M12/SD</b>	<b>120</b>	<b>M12</b>	<b>14.7</b>	<b>23.0</b>	<b>59.0</b>	<b>13.0</b>	<b>32.0</b>	<b>16.0</b>	<b>17.5</b>	<b>91.0</b>	<b>107.0</b>	<b>15</b>	<b>~0.9</b> kg.	<b>150</b>	<b>~9.0</b> kg.
AKP-DK/120-M16		M16	14.7	23.0	59.0	17.0	34.0	16.0	17.5	91.0	107.0	15	~0.9	150	~9.0
<b>AKP-DK/150-M12/SD</b>	<b>150</b>	<b>M12</b>	<b>16.3</b>	<b>25.0</b>	<b>62.0</b>	<b>13.0</b>	<b>35.0</b>	<b>17.5</b>	<b>20.0</b>	<b>103.0</b>	<b>120.5</b>	<b>12</b>	<b>~1.1</b> kg.	<b>120</b>	<b>~11.0</b> kg.
AKP-DK/150-M16		M16	16.3	25.0	62.0	17.0	35.0	17.5	20.0	103.0	120.5	12	~1.1	120	~11.0
AKP-DK/150-M20		M20	16.3	25.0	62.0	21.0	41.0	17.5	20.0	103.0	120.5	12	~1.1	120	~11.0
<b>AKP-DK/185-M12</b>	<b>185</b>	<b>M12</b>	<b>18.3</b>	<b>28.5</b>	<b>63.0</b>	<b>13.0</b>	<b>40.0</b>	<b>19.0</b>	<b>20.0</b>	<b>106.0</b>	<b>125.0</b>	<b>8</b>	<b>~1.1</b> kg.	<b>80</b>	<b>~11.0</b> kg.
<b>AKP-DK/185-M16/SD</b>		<b>M16</b>	<b>18.3</b>	<b>28.5</b>	<b>63.0</b>	<b>17.0</b>	<b>40.0</b>	<b>19.0</b>	<b>20.0</b>	<b>106.0</b>	<b>125.0</b>	<b>8</b>	<b>~1.1</b> kg.	<b>80</b>	<b>~11.0</b> kg.
AKP-DK/185-M20		M20	18.3	28.5	63.0	21.0	40.0	19.0	20.0	106.0	125.0	8	~1.1	80	~11.0
<b>AKP-DK/240-M12</b>	<b>240</b>	<b>M12</b>	<b>21.0</b>	<b>32.0</b>	<b>72.0</b>	<b>13.0</b>	<b>45.0</b>	<b>23.0</b>	<b>24.0</b>	<b>116.0</b>	<b>139.0</b>	<b>8</b>	<b>~1.4</b> kg.	<b>80</b>	<b>~14.0</b> kg.
<b>AKP-DK/240-M16/SD</b>		<b>M16</b>	<b>21.0</b>	<b>32.0</b>	<b>72.0</b>	<b>17.0</b>	<b>45.0</b>	<b>23.0</b>	<b>24.0</b>	<b>116.0</b>	<b>139.0</b>	<b>8</b>	<b>~1.4</b> kg.	<b>80</b>	<b>~14.0</b> kg.
AKP-DK/240-M20		M20	21.0	32.0	72.0	21.0	45.0	23.0	24.0	116.0	139.0	8	~1.4	80	~14.0
<b>AKP-DK/300-M16/SD</b>	<b>300</b>	<b>M16</b>	<b>23.3</b>	<b>34.0</b>	<b>74.0</b>	<b>17.0</b>	<b>49.0</b>	<b>24.0</b>	<b>25.0</b>	<b>124.0</b>	<b>148.0</b>	<b>5</b>	<b>~1.2</b> kg.	<b>50</b>	<b>~12.0</b> kg.
AKP-DK/300-M20		M20	23.3	34.0	74.0	21.0	49.0	24.0	25.0	124.0	148.0	5	~1.2	50	~12.0
<b>AKP-DK/400-M16/SD</b>	<b>400</b>	<b>M16</b>	<b>26.0</b>	<b>38.5</b>	<b>105.0</b>	<b>17.0</b>	<b>58.0</b>	<b>30.0</b>	<b>32.0</b>	<b>166.0</b>	<b>196.0</b>	<b>10</b>	<b>~3.3</b> kg.	<b>20</b>	<b>~33.0</b> kg.
AKP-DK/400-M20		M20	26.0	38.5	105.0	21.0	58.0	30.0	32.0	166.0	196.0	10	~3.3	20	~33.0

**AKP-DK SPECIFICATIONS**

MATERIAL	ELECTROLYTIC ALUMINIUM
COATING	TIN PLATED
JOINT	CLAMP COUPLING
CONFORMED TO DIN 46329 TUBE DIMENSIONS	

THE CABLE LUGS WHICH ARE INDICATED IN BOLD FONT, ARE STANDARD PRODUCTS OF **Simpa**



# AEM-D

DIN 46267-2 TYPE ALUMINIUM BUTT CONNECTORS

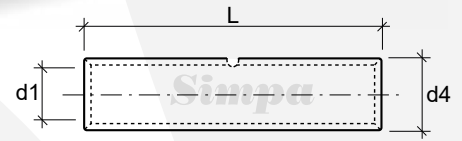

All rights reserved.

Order Code	Cable Section (mm <sup>2</sup> )	Dimensions			Box Pcs.	Box Weight	Parcel Pcs.	Box Weight
		d1	d4	L				
AEM-D/010	10	5,0	10,0	55,0	150	~1,5 kg.	1 500	~15,0 kg.
AEM-D/016	16	5,8	12,0	55,0	110	~1,5 kg.	1 100	~15,0 kg.
AEM-D/025	25	6,8	12,0	70,0	100	~1,5 kg.	1 000	~15,0 kg.
AEM-D/035	35	8,0	14,0	85,0	60	~1,4 kg.	600	~14,0 kg.
AEM-D/050	50	9,8	16,0	85,0	45	~1,3 kg.	450	~13,0 kg.
AEM-D/070	70	11,2	18,5	105,0	20	~1,0 kg.	200	~10,0 kg.
AEM-D/095	95	13,2	22,0	105,0	12	~0,9 kg.	120	~9,0 kg.
AEM-D/120	120	14,7	23,0	105,0	12	~0,9 kg.	120	~9,0 kg.
AEM-D/150	150	16,3	25,0	125,0	10	~1,0 kg.	100	~10,0 kg.
AEM-D/185	185	18,3	28,5	125,0	8	~1,1 kg.	80	~11,0 kg.
AEM-D/240	240	21,0	32,0	145,0	6	~1,1 kg.	60	~11,0 kg.
AEM-D/300	300	23,3	34,0	145,0	6	~1,2 kg.	60	~12,0 kg.
AEM-D/400	400	26,0	38,5	210,0	10	~3,5 kg.	20	~35,0 kg.

## AEM-D SPECIFICATIONS

MATERIAL	ELECTROLYTIC ALUMINIUM
COATING	NATURAL BRIGHT
JOINT	CLAMP COUPLING
CONFORMED TO DIN 46267-2 TUBE DIMENSIONS	





# BKP-D

## BIMETALLIC CABLE LUGS (AL-CU)

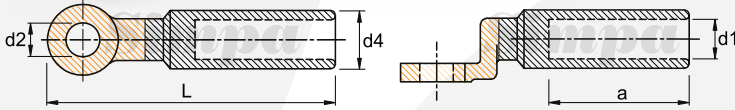

All rights reserved.

Order Code	Cable Section (mm <sup>2</sup> )	Bolt	Dimensions					Box Pcs.	Box Weight	Parcel Pcs.	Box Weight
			d1	d4	a	d2	L				
BKP-D/016-M08	16	M08	6,0	16,0	42,0	8,5	90,0	40	~2,1 kg.	400	~21,0 kg.
BKP-D/016-M10		M10	6,0	16,0	42,0	10,5	90,0	40	~2,1 kg.	400	~21,0 kg.
<b>BKP-D/016-M12/SD</b>		<b>M12</b>	<b>6,0</b>	<b>16,0</b>	<b>42,0</b>	<b>13,0</b>	<b>90,0</b>	<b>40</b>	<b>~2,1 kg.</b>	<b>400</b>	<b>~21,0 kg.</b>
BKP-D/025-M08	25	M08	7,0	16,0	42,0	8,5	90,0	40	~2,0 kg.	400	~20,0 kg.
BKP-D/025-M10		M10	7,0	16,0	42,0	10,5	90,0	40	~2,0 kg.	400	~20,0 kg.
<b>BKP-D/025-M12/SD</b>		<b>M12</b>	<b>7,0</b>	<b>16,0</b>	<b>42,0</b>	<b>13,0</b>	<b>90,0</b>	<b>40</b>	<b>~2,0 kg.</b>	<b>400</b>	<b>~20,0 kg.</b>
BKP-D/035-M08	35	M08	8,5	16,0	42,0	8,5	90,0	40	~2,0 kg.	400	~20,0 kg.
BKP-D/035-M10		M10	8,5	16,0	42,0	10,5	90,0	40	~2,0 kg.	400	~20,0 kg.
<b>BKP-D/035-M12/SD</b>		<b>M12</b>	<b>8,5</b>	<b>16,0</b>	<b>42,0</b>	<b>13,0</b>	<b>90,0</b>	<b>40</b>	<b>~2,0 kg.</b>	<b>400</b>	<b>~20,0 kg.</b>
BKP-D/050-M08	50	M08	9,6	20,0	43,0	8,5	90,0	30	~2,0 kg.	300	~20,0 kg.
BKP-D/050-M10		M10	9,6	20,0	43,0	10,5	90,0	30	~2,0 kg.	300	~20,0 kg.
<b>BKP-D/050-M12/SD</b>		<b>M12</b>	<b>9,6</b>	<b>20,0</b>	<b>43,0</b>	<b>13,0</b>	<b>90,0</b>	<b>30</b>	<b>~2,0 kg.</b>	<b>300</b>	<b>~20,0 kg.</b>
BKP-D/070-M08	70	M08	11,5	20,0	43,0	8,5	90,0	30	~2,0 kg.	300	~20,0 kg.
BKP-D/070-M10		M10	11,5	20,0	43,0	10,5	90,0	30	~2,0 kg.	300	~20,0 kg.
<b>BKP-D/070-M12/SD</b>		<b>M12</b>	<b>11,5</b>	<b>20,0</b>	<b>43,0</b>	<b>13,0</b>	<b>90,0</b>	<b>30</b>	<b>~2,0 kg.</b>	<b>300</b>	<b>~20,0 kg.</b>
BKP-D/095-M08	95	M08	13,5	20,0	43,0	8,5	90,0	30	~1,8 kg.	300	~18,0 kg.
BKP-D/095-M10		M10	13,5	20,0	43,0	10,5	90,0	30	~1,8 kg.	300	~18,0 kg.
<b>BKP-D/095-M12/SD</b>		<b>M12</b>	<b>13,5</b>	<b>20,0</b>	<b>43,0</b>	<b>13,0</b>	<b>90,0</b>	<b>30</b>	<b>~1,8 kg.</b>	<b>300</b>	<b>~18,0 kg.</b>
BKP-D/120-M08	120	M08	15,0	25,0	60,0	8,5	115,0	15	~1,9 kg.	150	~19,0 kg.
BKP-D/120-M10		M10	15,0	25,0	60,0	10,5	115,0	15	~1,9 kg.	150	~19,0 kg.
<b>BKP-D/120-M12/SD</b>		<b>M12</b>	<b>15,0</b>	<b>25,0</b>	<b>60,0</b>	<b>13,0</b>	<b>115,0</b>	<b>15</b>	<b>~1,9 kg.</b>	<b>150</b>	<b>~19,0 kg.</b>
BKP-D/150-M08	150	M08	16,6	25,0	60,0	8,5	115,0	15	~1,8 kg.	150	~18,0 kg.
BKP-D/150-M10		M10	16,6	25,0	60,0	10,5	115,0	15	~1,8 kg.	150	~18,0 kg.
<b>BKP-D/150-M12/SD</b>		<b>M12</b>	<b>16,6</b>	<b>25,0</b>	<b>60,0</b>	<b>13,0</b>	<b>115,0</b>	<b>15</b>	<b>~1,8 kg.</b>	<b>150</b>	<b>~18,0 kg.</b>
BKP-D/185-M08	185	M08	18,5	32,0	60,0	8,5	122,0	8	~1,8 kg.	80	~18,0 kg.
BKP-D/185-M10		M10	18,5	32,0	60,0	10,5	122,0	8	~1,8 kg.	80	~18,0 kg.
<b>BKP-D/185-M12/SD</b>		<b>M12</b>	<b>18,5</b>	<b>32,0</b>	<b>60,0</b>	<b>13,0</b>	<b>122,0</b>	<b>8</b>	<b>~1,8 kg.</b>	<b>80</b>	<b>~18,0 kg.</b>
BKP-D/240-M08	240	M08	21,0	32,0	60,0	8,5	122,0	8	~1,7 kg.	80	~17,0 kg.
BKP-D/240-M10		M10	21,0	32,0	60,0	10,5	122,0	8	~1,7 kg.	80	~17,0 kg.
<b>BKP-D/240-M12/SD</b>		<b>M12</b>	<b>21,0</b>	<b>32,0</b>	<b>60,0</b>	<b>13,0</b>	<b>122,0</b>	<b>8</b>	<b>~1,7 kg.</b>	<b>80</b>	<b>~17,0 kg.</b>
BKP-D/300-M08	300	M08	23,0	34,0	62,0	8,5	125,0	8	~1,8 kg.	80	~18,0 kg.
BKP-D/300-M10		M10	23,0	34,0	62,0	10,5	125,0	8	~1,8 kg.	80	~18,0 kg.
<b>BKP-D/300-M12/SD</b>		<b>M12</b>	<b>23,0</b>	<b>34,0</b>	<b>62,0</b>	<b>13,0</b>	<b>125,0</b>	<b>8</b>	<b>~1,8 kg.</b>	<b>80</b>	<b>~18,0 kg.</b>
<b>BKP-D/400-M12/SD</b>	<b>400</b>	<b>M12</b>	<b>26,0</b>	<b>38,0</b>	<b>70,0</b>	<b>13,0</b>	<b>159,0</b>	<b>5</b>	<b>~1,9 kg.</b>	<b>50</b>	<b>~19,0 kg.</b>
<b>BKP-D/500-M18/SD</b>	<b>500</b>	<b>M18</b>	<b>29,0</b>	<b>47,0</b>	<b>75,0</b>	<b>19,0</b>	<b>167,0</b>	<b>3</b>	<b>~1,8 kg.</b>	<b>30</b>	<b>~18,0 kg.</b>
<b>BKP-D/625-M20/SD</b>	<b>625</b>	<b>M20</b>	<b>34,0</b>	<b>54,0</b>	<b>80,0</b>	<b>21,0</b>	<b>200,0</b>	<b>8</b>	<b>~6,8 kg.</b>	<b>16</b>	<b>~13,8 kg.</b>

### BKP-D SPECIFICATIONS

MATERIAL	ELECTROLYTIC COPPER / ALUMINIUM
COATING	NATURAL BRIGHT
JOINT	CLAMP COUPLING
COMPLY WITH DIN 48201 ALUMINIUM CABLE	
CONFORMED TO DIN 46329 TUBE DIMENSIONS	



# BEM-D

BIMETALLIC BUTT CONNECTORS (AL-CU)

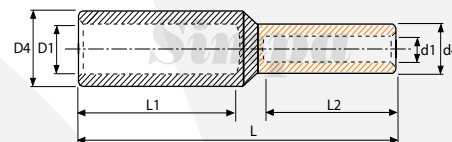

All rights reserved.

Order Code	Cable Section (mm <sup>2</sup> )	Dimensions							Box Pcs.	Box Weight	Parcel Pcs.	Box Weight
		D1	D4	d1	d4	L1	L2	L				
BEM-D/010-006	<b>10 / 6</b>	5,5	10,0	5,0	9,0	32,0	25,0	70,0	140	~2,6 kg.	1.400	~26,0 kg.
BEM-D/016-010	<b>16 / 10</b>	5,5	10,0	5,5	9,0	35,0	28,0	75,0	140	~2,5 kg.	1.400	~25,0 kg.
BEM-D/025-010	<b>25 / 10</b>	7,0	12,0	5,5	9,0	37,0	28,0	78,0	100	~2,2 kg.	1.000	~22,0 kg.
BEM-D/025-016	<b>25 / 16</b>	7,0	12,0	6,0	10,0	37,0	30,0	80,0	100	~2,6 kg.	1.000	~26,0 kg.
BEM-D/025-025	<b>25 / 25</b>	7,0	12,0	7,0	11,0	37,0	28,0	82,0	100	~3,0 kg.	1.000	~30,0 kg.
BEM-D/035-016	<b>35 / 16</b>	8,5	14,0	6,0	10,0	44,0	30,0	88,0	70	~2,2 kg.	700	~22,0 kg.
BEM-D/035-025	<b>35 / 25</b>	8,5	14,0	7,0	11,0	44,0	32,0	90,0	70	~2,3 kg.	700	~23,0 kg.
BEM-D/035-035	<b>35 / 35</b>	8,5	14,0	8,5	12,0	44,0	32,0	90,0	60	~2,4 kg.	600	~24,0 kg.
BEM-D/050-025	<b>50 / 25</b>	9,5	16,0	7,0	11,0	45,0	32,0	90,0	50	~2,5 kg.	700	~25,0 kg.
BEM-D/050-035	<b>50 / 35</b>	9,5	16,0	8,5	12,0	45,0	34,0	95,0	50	~2,6 kg.	500	~26,0 kg.
BEM-D/050-050	<b>50 / 50</b>	9,5	16,0	9,5	14,0	45,0	35,0	95,0	40	~2,8 kg.	400	~28,0 kg.
BEM-D/070-035	<b>70 / 35</b>	12,0	18,0	8,5	12,0	46,0	34,0	100,0	35	~2,0 kg.	350	~20,0 kg.
BEM-D/070-050	<b>70 / 50</b>	12,0	18,0	9,5	14,0	46,0	35,0	100,0	35	~2,1 kg.	350	~21,0 kg.
BEM-D/095-035	<b>95 / 35</b>	13,0	21,0	8,5	12,0	51,0	34,0	100,0	25	~1,3 kg.	250	~13,0 kg.
BEM-D/095-050	<b>95 / 50</b>	13,0	21,0	9,5	14,0	51,0	35,0	105,0	20	~1,3 kg.	200	~13,0 kg.
BEM-D/095-070	<b>95 / 70</b>	13,0	21,0	12,0	16,0	51,0	41,0	110,0	20	~1,4 kg.	200	~14,0 kg.
BEM-D/120-095	<b>120 / 95</b>	15,0	23,0	13,0	18,0	52,0	43,0	112,0	15	~1,5 kg.	150	~15,0 kg.
BEM-D/150-070	<b>150 / 70</b>	16,0	25,0	12,0	16,0	54,0	41,0	113,0	12	~1,5 kg.	120	~15,0 kg.
BEM-D/150-095	<b>150 / 95</b>	16,0	25,0	13,0	18,0	54,0	43,0	117,0	12	~1,5 kg.	120	~15,0 kg.
BEM-D/150-120	<b>150 / 120</b>	16,0	25,0	15,0	20,0	54,0	44,0	118,0	12	~2,0 kg.	120	~20,0 kg.
BEM-D/185-150	<b>185 / 150</b>	18,0	27,0	16,0	22,0	58,0	47,0	125,0	12	~1,9 kg.	120	~19,0 kg.
BEM-D/240-150	<b>240 / 150</b>	20,0	30,0	16,0	22,0	60,0	47,0	125,0	8	~1,7 kg.	80	~17,0 kg.
BEM-D/240-185	<b>240 / 185</b>	20,0	30,0	18,0	25,0	60,0	48,0	130,0	8	~1,8 kg.	80	~18,0 kg.
BEM-D/300-240	<b>300 / 240</b>	23,0	34,0	20,0	27,0	65,0	55,0	140,0	6	~2,3 kg.	60	~23,0 kg.
BEM-D/400-240	<b>400 / 240</b>	26,0	38,0	20,0	27,0	70,0	55,0	145,0	6	~1,8 kg.	60	~18,0 kg.
BEM-D/400-300	<b>400 / 300</b>	26,0	38,0	24,0	30,0	70,0	60,0	150,0	6	~1,9 kg.	60	~19,0 kg.
BEM-D/500-400	<b>500 / 400</b>	29,0	42,0	26,0	34,0	75,0	65,0	160,0	4	~1,8 kg.	40	~18,0 kg.
BEM-D/625-500	<b>625 / 500</b>	34,0	54,0	30,0	38,0	80,0	70,0	170,0	1	~0,7 kg.	10	~7,0 kg.

## BEM-D SPECIFICATIONS

MATERIAL	ELECTROLYTIC COPPER / ALUMINIUM
COATING	NATURAL BRIGHT
JOINT	CLAMP COUPLING





# BPK-D

## BIMETALLIC PIN TYPE CONNECTORS (AL-CU)

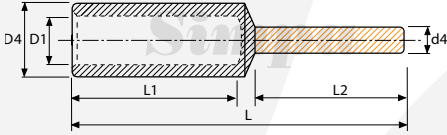

All rights reserved.

Order Code	Cable Section (mm <sup>2</sup> )	Dimensions					Box Pcs.	Box Weight	Parcel Pcs.	Box Weight
		D1	D4	L1	L2	d4				
BPK-D/010	<b>10</b>	5,5	16,0	42,0	25,0	7,0	60	~2,1 kg.	600	~21,0 kg.
BPK-D/016	<b>16</b>	6,0	16,0	42,0	25,0	7,0	60	~2,2 kg.	600	~22,0 kg.
BPK-D/025	<b>25</b>	7,0	16,0	42,0	25,0	7,0	60	~2,2 kg.	600	~22,0 kg.
BPK-D/035	<b>35</b>	8,5	16,0	42,0	25,0	7,0	60	~2,3 kg.	600	~23,0 kg.
BPK-D/050	<b>50</b>	9,6	20,0	50,0	35,0	12,0	30	~2,4 kg.	300	~24,0 kg.
BPK-D/070	<b>70</b>	11,5	20,0	50,0	35,0	12,0	30	~2,4 kg.	300	~24,0 kg.
BPK-D/095	<b>95</b>	13,5	20,0	50,0	35,0	12,0	30	~2,5 kg.	300	~25,0 kg.
BPK-D/120	<b>120</b>	15,0	25,0	60,0	38,0	14,0	15	~2,0 kg.	150	~20,0 kg.
BPK-D/150	<b>150</b>	16,6	25,0	60,0	38,0	14,0	15	~2,0 kg.	150	~20,0 kg.

### BPK-D SPECIFICATIONS

MATERIAL	ELECTROLYTIC COPPER / ALUMINIUM
COATING	NATURAL BRIGHT
JOINT	CLAMP COUPLING



# 1-TBE

1 PHASE / L1 INSULATED COMB BUSBARS PIN TYPE



All rights reserved.

Order Code	Module	Copper Thickness	Maximum Current Value	Operating Voltage	Box Pcs.	Box Weight	Parcel Pcs.	Box Weight
1TBE-30/1,0	For 30 Modules of MCB	1,0 mm.	80 A	230-400 V	30	~3,0 kg.	150	~15,0 kg.
1TBE-MT/1,0	For 56 Modules of MCB	1,0 mm.	80 A	230-400 V	30	~5,9 kg.	90	~17,7 kg.
1TBE-12/1,5	For 12 Modules of MCB	1,5 mm.	100 A	230-400 V	60	~3,0 kg.	300	~15,0 kg.
1TBE-18/1,5	For 18 Modules of MCB	1,5 mm.	100 A	230-400 V	30	~2,3 kg.	150	~11,5 kg.
1TBE-24/1,5	For 24 Modules of MCB	1,5 mm.	100 A	230-400 V	30	~3,1 kg.	150	~15,5 kg.
1TBE-30/1,5	For 30 Modules of MCB	1,5 mm.	100 A	230-400 V	30	~3,7 kg.	150	~18,5 kg.
1TBE-MT/1,5	For 56 Modules of MCB	1,5 mm.	100 A	230-400 V	30	~7,1 kg.	90	~21,3 kg.

# 2-TBE

2 PHASE / L1+L2(N) INSULATED COMB BUSBARS PIN TYPE

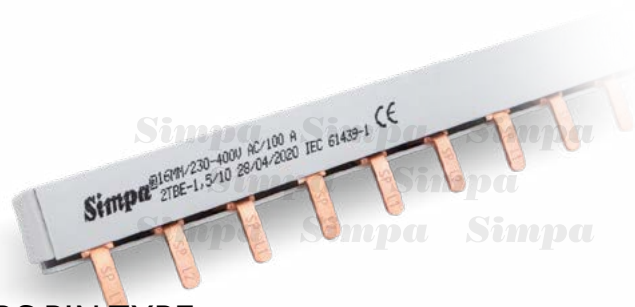

All rights reserved.

Order Code	Module	Copper Thickness	Maximum Current Value	Operating Voltage	Box Pcs.	Box Weight	Parcel Pcs.	Box Weight
2TBE-06/1,0	For 6 Modules of MCB	1,0 mm.	80 A	230-400 V	24	~2,2 kg.	120	~11,0 kg.
2TBE-09/1,0	For 9 Modules of MCB	1,0 mm.	80 A	230-400 V	12	~1,7 kg.	60	~8,5 kg.
2TBE-12/1,0	For 12 Modules of MCB	1,0 mm.	80 A	230-400 V	12	~2,2 kg.	60	~11,0 kg.
2TBE-15/1,0	For 15 Modules of MCB	1,0 mm.	80 A	230-400 V	12	~2,7 kg.	60	~13,5 kg.
2TBE-MT/1,0	For 28 Modules of MCB	1,0 mm.	80 A	230-400 V	10	~4,3 kg.	30	~12,9 kg.
2TBE-06/1,5	For 6 Modules of MCB	1,5 mm.	100 A	230-400 V	24	~1,4 kg.	120	~7,0 kg.
2TBE-09/1,5	For 9 Modules of MCB	1,5 mm.	100 A	230-400 V	12	~2,1 kg.	60	~10,5 kg.
2TBE-12/1,5	For 12 Modules of MCB	1,5 mm.	100 A	230-400 V	12	~2,7 kg.	60	~13,5 kg.
2TBE-15/1,5	For 15 Modules of MCB	1,5 mm.	100 A	230-400 V	12	~3,4 kg.	60	~17,0 kg.
2TBE-MT/1,5	For 28 Modules of MCB	1,5 mm.	100 A	230-400 V	10	~5,5 kg.	30	~16,5 kg.



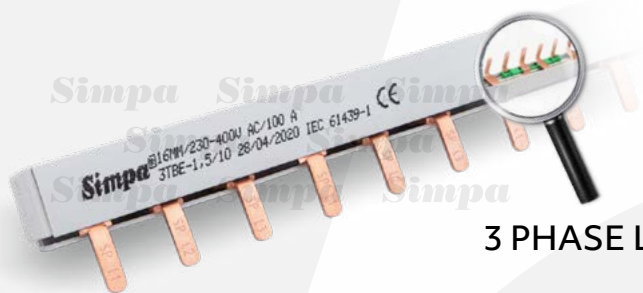

# 3-TBE

3 PHASE L1+L2+L3 INSULATED COMB BUSBARS PIN TYPE

All rights reserved.

Order Code	Module	Copper Thickness	Maximum Current Value	Operating Voltage	Box Pcs.	Box Weight	Parcel Pcs.	Box Weight
3TBE-10/0,8	For 10 Modules of MCB	0,8 mm.	63 A	230-400 V	24	~2,2 kg.	120	~11,0 kg.
3TBE-MT/0,8	For 19 Modules of MCB	0,8 mm.	63 A	230-400 V	10	~1,8 kg.	60	~9,0 kg.
3TBE-04/1,0	For 04 Modules of MCB	1,0 mm.	80 A	230-400 V	24	~2,5 kg.	120	~12,5 kg.
3TBE-06/1,0	For 06 Modules of MCB	1,0 mm.	80 A	230-400 V	12	~2,0 kg.	60	~10,0 kg.
3TBE-08/1,0	For 08 Modules of MCB	1,0 mm.	80 A	230-400 V	12	~2,6 kg.	60	~13,0 kg.
3TBE-10/1,0	For 10 Modules of MCB	1,0 mm.	80 A	230-400 V	12	~3,2 kg.	60	~16,0 kg.
3TBE-MT/1,0	For 19 Modules of MCB	1,0 mm.	80 A	230-400 V	10	~5,3 kg.	30	~15,9 kg.
3TBE-04/1,5	For 4 Modules of MCB	1,5 mm.	100 A	230-400 V	24	~3,2 kg.	120	~16,0 kg.
3TBE-06/1,5	For 6 Modules of MCB	1,5 mm.	100 A	230-400 V	12	~2,6 kg.	60	~13,0 kg.
3TBE-08/1,5	For 8 Modules of MCB	1,5 mm.	100 A	230-400 V	12	~3,3 kg.	60	~16,5 kg.
3TBE-10/1,5	For 10 Modules of MCB	1,5 mm.	100 A	230-400 V	12	~4,2 kg.	60	~21,0 kg.
3TBE-MT/1,5	For 19 Modules of MCB	1,5 mm.	100 A	230-400 V	10	~6,8 kg.	30	~20,4 kg.

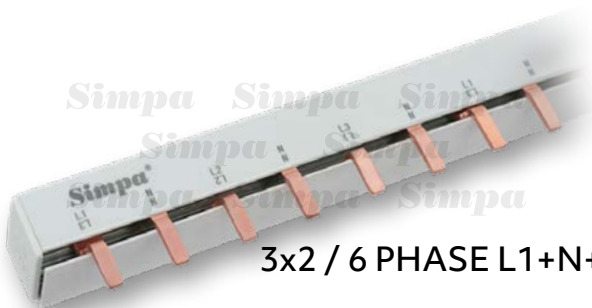

# 3x2-TBE

3x2 / 6 PHASE L1+N+L2+N+L3+N INSULATED COMB BUSBAR PIN TYPE

All rights reserved.

Order Code	Module	Copper Thickness	Maximum Current Value	Operating Voltage	Box Pcs.	Box Weight	Parcel Pcs.	Box Weight
3X(2TBE)-MT/1,5	For 9 Modules of MCB	1,5 mm.	100 A	230-400 V	8	~6,5 kg.	24	~19,5 kg.

# 4-TBE

FOUR PHASE L1+L2+L3+N INSULATED  
COMB BUSBARS PIN TYPE

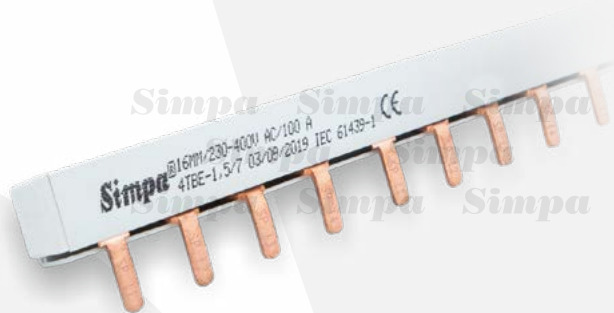

All rights reserved.

Order Code	Module	Copper Thickness	Maximum Current Value	Operating Voltage	Box Pcs.	Box Weight	Parcel Pcs.	Box Weight
4TBE-04/1,5	For 4 Modules of MCB	1,5 mm.	100 A	230-400 V	8	~2,0 kg.	40	~10,0 kg.
4TBE-05/1,5	For 5 Modules of MCB	1,5 mm.	100 A	230-400 V	8	~2,8 kg.	40	~14,0 kg.
4TBE-06/1,5	For 6 Modules of MCB	1,5 mm.	100 A	230-400 V	8	~3,0 kg.	40	~15,0 kg.
4TBE-07/1,5	For 7 Modules of MCB	1,5 mm.	100 A	230-400 V	8	~3,5 kg.	40	~17,5 kg.
4TBE-08/1,5	For 8 Modules of MCB	1,5 mm.	100 A	230-400 V	8	~3,9 kg.	40	~19,5 kg.
4TBE-MT/1,5	For 14 Modules of MCB	1,5 mm.	100 A	230-400 V	8	~6,8 kg.	24	~20,4 kg.

# PROTECTIVE BUSBAR CAPS



All rights reserved.

Order Code	Box Pcs.	Box Weight
MONOPHASE PROTECTIVE BUSBAR CAPS	150	~0,1 kg.
2 & 3 PHASE PROTECTIVE BUSBAR CAPS	125	~0,1 kg.
3+N PHASE PROTECTIVE BUSBAR CAPS	75	~0,1 kg.
(3x2) 6 PHASE PROTECTIVE BUSBAR CAPS	50	~0,1 kg.





# BUSBAR FEED-IN TERMINALS

All rights reserved.

Order Code	Description	Cable Section (mm <sup>2</sup> )	Bolt	Box Pcs.	Box Weight
1TBK/025	25mm <sup>2</sup> Busbar Feed-in Terminal	25	M08	20	~0,21 kg.
1TBK/050	50mm <sup>2</sup> Busbar Feed-in Terminal	50	M10	10	~0,22 kg.

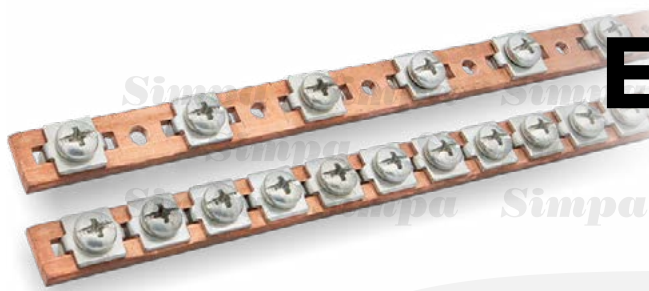

# EARTHING BARS

All rights reserved.

Order Code	Distribution	Copper Thickness	Box Pcs.	Box Weight	Parcel Pcs.	Box Weight
KUB-1,5/31	<b>31 SCREW</b>	1,5x15,0	10	~3,3 kg.	40	~13,2 kg.
KUB-1,5/61	<b>61 SCREW</b>	1,5x15,0	10	~4,6 kg.	40	~18,4 kg.
KUB-2,0/31	<b>31 SCREW</b>	2,0x15,0	10	~3,9 kg.	40	~15,6 kg.
KUB-2,0/61	<b>61 SCREW</b>	2,0x15,0	10	~5,2 kg.	40	~20,8 kg.
KUB-3,0/31	<b>31 SCREW</b>	3,0x15,0	10	~5,0 kg.	40	~20,0 kg.
KUB-3,0/61	<b>61 SCREW</b>	3,0x15,0	10	~6,3 kg.	40	~25,2 kg.



# 3-TBD

3 PHASE INSULATED COMB BUSBARS FORK TYPE



All rights reserved.

Order Code	Module	Copper Thickness	Maximum Current Value	Operating Voltage	Box Pcs.	Box Weight
3TBD-04/1,0	For 4 Modules of MCB	1,0 mm.	80 A	230 - 400 V	24	~2,3 kg.
3TBD-10/1,0	For 10 Modules of MCB	1,0 mm.	80 A	230 - 400 V	12	~3,4 kg.
3TBD-04/1,5	For 4 Modules of MCB	1,5 mm.	100 A	230 - 400 V	24	~3,6 kg.
3TBD-10/1,5	For 10 Modules of MCB	1,5 mm.	100 A	230 - 400 V	12	~4,5 kg.

# 1 BOB-E

1 PHASE NON-INSULATED COMB BUSBARS PIN TYPE

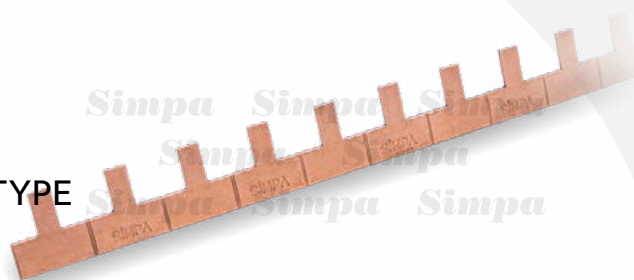

All rights reserved.

Order Code	Be Used	Copper Thickness	Box Pcs.	Box Weight	Parcel Pcs.	Box Weight
1BOB-E/1,5	Monophase N type MCB	1,5 mm.	20	~3,3 kg.		
1BOB-E/2,0	Monophase N type MCB	2,0 mm.	20			

# 1 BOB-D

1 PHASE NON-INSULATED COMB BUSBARS FORK TYPE



All rights reserved.

Order Code	Be Used	Copper Thickness	Box Pcs.	Box Weight	Parcel Pcs.	Box Weight
1BOB-D/1,5	Monophase W type MCB	1,5 mm.	20			
1BOB-D/2,0	Monophase W type MCB	2,0 mm.	20	~4,6 kg.		

## MECHANICAL CABLE CUTTERS



### **SP-KM/250**

CABLE TYPE - CROSS SECTION	Cu & Al $\leq$ 250 mm <sup>2</sup>
PRODUCT LENGTH	600 mm
PRODUCT WEIGHT	1.70 Kg



### **SP-KM/500**

CABLE TYPE - CROSS SECTION	Cu & Al $\leq$ 500 mm <sup>2</sup>
PRODUCT LENGTH	800 mm
PRODUCT WEIGHT	2.70 Kg



### **SP-KMG/500**

CABLE TYPE - CROSS SECTION	Cu & Al $\leq$ 500 mm <sup>2</sup>
PRODUCT LENGTH	240-300 mm
PRODUCT WEIGHT	1,13 Kg

THE STEEL BLADES OF PRODUCTS HAVE HIGH DURABILITY DUE TO THE APPLIED HEAT TREATMENT AND FORGING PROCESSES.  
CAST ALUMINUM ARMS PROVIDE DURABILITY & LIGHTNESS.  
PVC PLASTIC HANDLES ENSURE ERGONOMIC USAGE.

# KBB/KBS CABLE TIES

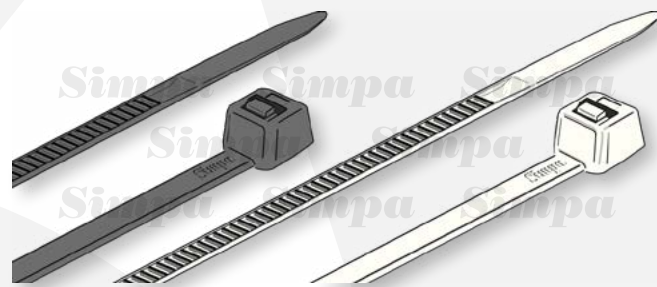

All rights reserved.

## KBB - WHITE CABLE TIES

Order Code	Dimensions (mm)	Max. Tensile Strength	Color	Bag Pcs.	Master Bag Pcs.	Parcel Pcs.	Parcel Weight
SP-KBB/2.5x100	2.5x100	80 N / 8 kg	White	100	1.000	50.000	~15,0 kg.
SP-KBB/2.5x142	2.5x142	80 N / 8 kg	White	100	1.000	25.000	~11,2 kg.
SP-KBB/2.5x203	2.5x203	80 N / 8 kg	White	100	1.000	20.000	~12,8 kg.
SP-KBB/3.6x150	3.6x150	180 N / 18 kg	White	100	1.000	20.000	~14,0 kg.
SP-KBB/3.6x250	3.6x250	180 N / 18 kg	White	100	1.000	10.000	~12,5 kg.
SP-KBB/3.6x292	3.6x292	180 N / 18 kg	White	100	1.000	10.000	~15,2 kg.
SP-KBB/3.6x368	3.6x368	180 N / 18 kg	White	100	1.000	10.000	~17,5 kg.
SP-KBB/4.8x190	4.8x190	230 N / 23 kg	White	100	1.000	10.000	~13,0 kg.
SP-KBB/4.8x368	4.8x368	230 N / 23 kg	White	100	1.000	5.000	~12,8 kg.
SP-KBB/7.6x300	7.6x300	540 N / 55 kg	White	100	500	5.000	~19,5 kg.
SP-KBB/7.6x380	7.6x380	540 N / 55 kg	White	100	500	5.000	~24,0 kg.
SP-KBB/7.6x450	7.6x450	540 N / 55 kg	White	100	100	2.000	~12,1 kg.
SP-KBB/8.8x762	8.8x762	800 N / 81 kg	White	100	100	1.000	~12,6 kg.

## KBS - BLACK CABLE TIES

Order Code	Dimensions (mm)	Max. Tensile Strength	Color	Bag Pcs.	Master Bag Pcs.	Parcel Pcs.	Parcel Weight
SP-KBS/2.5x100	2.5x100	80 N / 8 kg	Black	100	1.000	50.000	~15,0 kg.
SP-KBS/2.5x142	2.5x142	80 N / 8 kg	Black	100	1.000	25.000	~11,2 kg.
SP-KBS/2.5x203	2.5x203	80 N / 8 kg	Black	100	1.000	20.000	~12,8 kg.
SP-KBS/3.6x150	3.6x150	180 N / 18 kg	Black	100	1.000	20.000	~14,0 kg.
SP-KBS/3.6x250	3.6x250	180 N / 18 kg	Black	100	1.000	10.000	~12,5 kg.
SP-KBS/3.6x292	3.6x292	180 N / 18 kg	Black	100	1.000	10.000	~15,2 kg.
SP-KBS/3.6x368	3.6x368	180 N / 18 kg	Black	100	1.000	10.000	~17,5 kg.
SP-KBS/4.8x190	4.8x190	230 N / 23 kg	Black	100	1.000	10.000	~13,0 kg.
SP-KBS/4.8x368	4.8x368	230 N / 23 kg	Black	100	1.000	5.000	~12,8 kg.
SP-KBS/7.6x300	7.6x300	540 N / 55 kg	Black	100	500	5.000	~19,5 kg.
SP-KBS/7.6x380	7.6x380	540 N / 55 kg	Black	100	500	5.000	~24,0 kg.
SP-KBS/7.6x450	7.6x450	540 N / 55 kg	Black	100	100	2.000	~12,1 kg.
SP-KBS/8.8x762	8.8x762	800 N / 81 kg	Black	100	100	1.000	~12,6 kg.

# SELF ADHESIVE AND SCREWABLE TIE MOUNTS

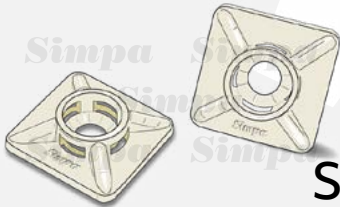

## SP-YKB - SELF ADHESIVE WHITE TIE MOUNT

Order Code	Dimensions (mm)	Color	Package Pcs.	Master Bag Pcs.	Parcel Pcs.	Box Weight
SP-YKB-1	19x19	White	100	500	18.000	~15,7 kg.
SP-YKB-2	28x28	White	100	500	7.000	~13,6 kg.

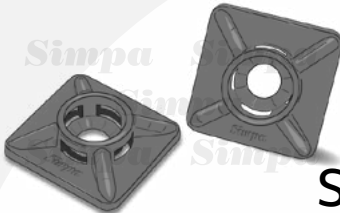

## SP-YKS - SELF ADHESIVE BLACK TIE MOUNT

Order Code	Dimensions (mm)	Color	Package Pcs.	Master Bag Pcs.	Parcel Pcs.	Box Weight
SP-YKS-1	19x19	Black	100	500	18.000	~15,7 kg.
SP-YKS-2	28x28	Black	100	500	7.000	~13,6 kg.

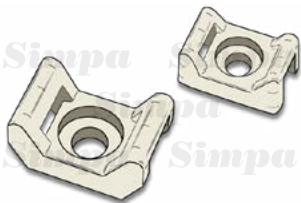

## SP-VKB - SCREW TYPE WHITE TIE MOUNT

Order Code	Dimensions (mm)	Color	Package Pcs.	Master Bag Pcs.	Parcel Pcs.	Box Weight
SP-VKB-1	16x10,5	White	100	500	15.000	~15,6 kg.
SP-VKB-2	22x14,5	White	100	500	5.000	~11,0 kg.

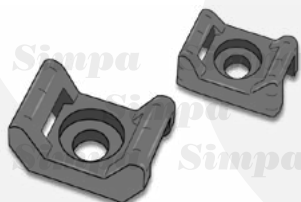

## SP-VKS - SCREW TYPE BLACK TIE MOUNT

Order Code	Dimensions (mm)	Color	Package Pcs.	Master Bag Pcs.	Parcel Pcs.	Box Weight
SP-VKS-1	16x10,5	Black	100	500	15.000	~15,6 kg.
SP-VKS-2	22x14,5	Black	100	500	5.000	~11,0 kg.

# THE RIGHT CHOICE FOR PROJECTS THAT REQUIRE SPECIAL SOLUTIONS

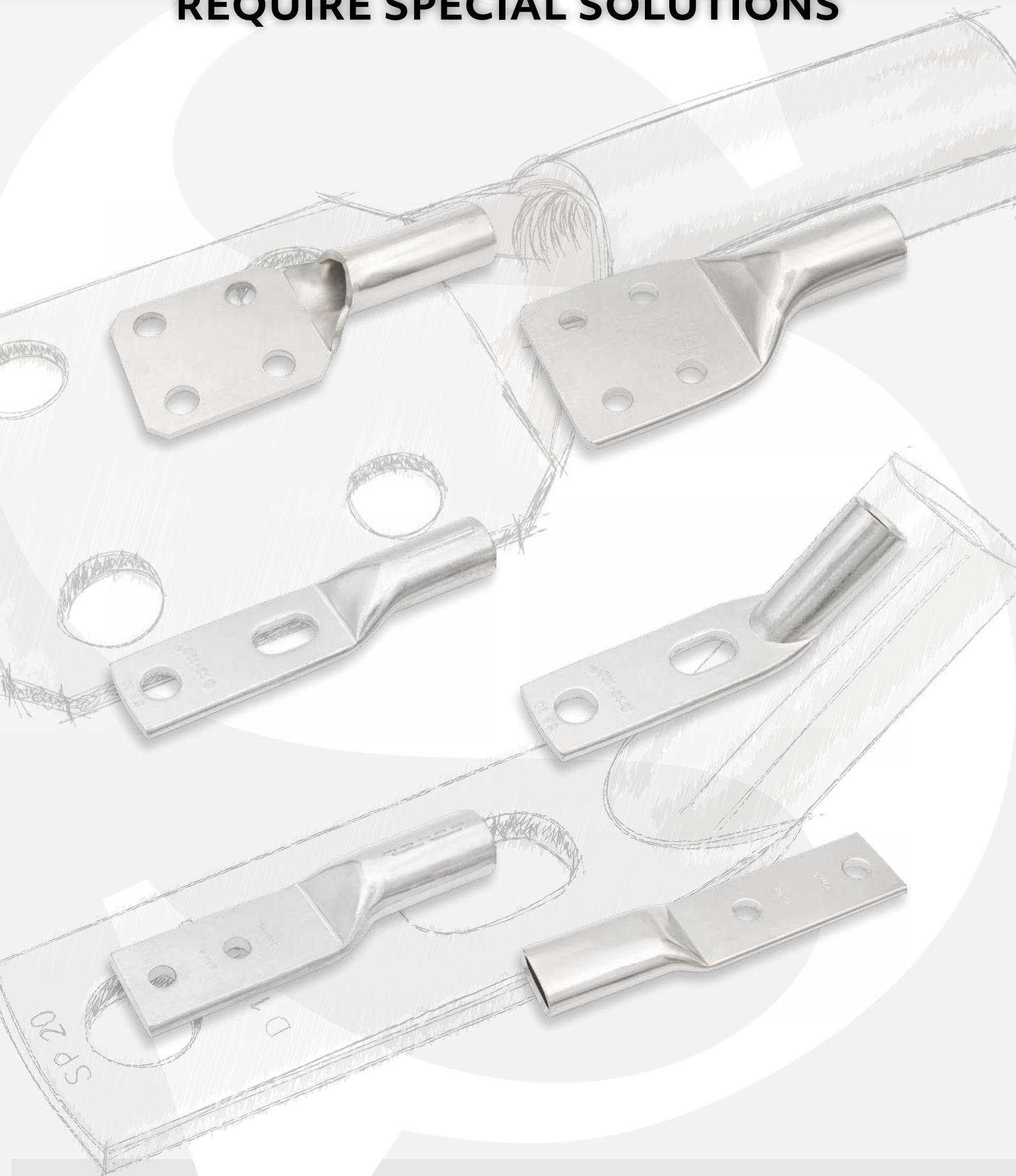



# SP-KY

## NON-INSULATED SLEEVES

All rights reserved.

Order Code	Cable Section (mm <sup>2</sup> )	Dimensions				Box Pcs.	Box Weight
		L	W	D	C		
SP-KY/0,50-10	<b>0,50</b>	10	1,7	1,3	1,0	1.000	~0,1 kg.
SP-KY/0,75-10	<b>0,75</b>	10	1,9	1,5	1,2	1.000	~0,1 kg.
SP-KY/1,0-10	<b>1</b>	10	2,2	1,8	1,4	1.000	~0,1 kg.
SP-KY/1,5-10	<b>1,5</b>	10	2,5	2,0	1,7	1.000	~0,1 kg.
SP-KY/2,5-12	<b>2,5</b>	12	3,3	2,6	2,2	1.000	~0,1 kg.
SP-KY/4-12	<b>4</b>	12	3,9	3,2	2,8	500	~0,1 kg.
SP-KY/6-12	<b>6</b>	12	4,8	3,9	3,5	250	~0,1 kg.
SP-KY/10-12	<b>10</b>	12	5,8	4,9	4,5	250	~0,1 kg.
SP-KY/16-12	<b>16</b>	12	7,2	6,2	5,8	100	~0,1 kg.
SP-KY/25-15	<b>25</b>	16	9,1	7,9	7,5	100	~0,1 kg.
SP-KY/35-15	<b>35</b>	16	10,2	8,7	8,3	50	~0,1 kg.
SP-KY/50-20	<b>50</b>	20	12,4	10,9	10,3	40	~0,1 kg.
SP-KY/70-25	<b>70</b>	25	15,8	14,3	13,5	20	~0,2 kg.
SP-KY/95-25	<b>95</b>	25	19,3	15,6	14,6	20	~0,2 kg.
SP-KY/120-32	<b>120</b>	32	20,2	17,7	16,7	15	~0,2 kg.
SP-KY/150-32	<b>150</b>	32	23,0	20,6	19,6	10	~0,2 kg.

### SK-KY SPECIFICATIONS

MATERIAL	COPPER
COATING	TIN PLATED

FOR THE INSULATED CONNECTORS, THE FIRST PART OF THE PRODUCT CODE INDICATES THE DIAMETER AND THE SECOND PART INDICATES LENGTH OF THE PRODUCT.



# SP-IKY

## INSULATED CABLE END-SLEEVES

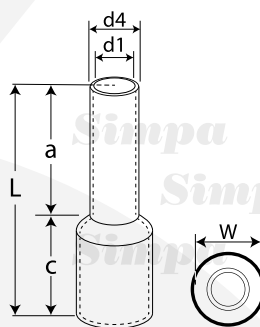

All rights reserved.

Order Code	Cable Section (mm <sup>2</sup> )	Dimensions						Color	Box Pcs.	Box Weight
		c	a	L	W	d4	d1			
SP-IKY/0,50-8	<b>0,5</b>	6,0	8,0	14,0	2,6	1,3	1,0	Orange	1.000	~0,2 kg.
SP-IKY/0,75-8	<b>0,75</b>	6,0	8,0	14,0	2,8	1,5	1,2	White	1.000	~0,3 kg.
SP-IKY/1,0-8	<b>1</b>	6,0	8,0	14,0	3,0	1,7	1,4	Yellow	1.000	~0,1 kg.
SP-IKY/1,5-8	<b>1,5</b>	6,0	8,0	14,0	3,5	2,0	1,7	Red	700	~0,1 kg.
SP-IKY/1,5-10		6,0	10,0	16,0	3,5	2,0	1,7	Red	600	~0,2 kg.
SP-IKY/1,5-18		6,0	18,0	24,0	3,5	2,0	1,7	Red	400	~0,2 kg.
SP-IKY/2,5-8	<b>2,5</b>	7,0	8,0	15,0	4,0	2,6	2,3	Blue	500	~0,3 kg.
SP-IKY/2,5-12		7,0	10,0	17,0	4,0	2,6	2,3	Blue	400	~0,2 kg.
SP-IKY/2,5-18		7,0	18,0	25,0	4,0	2,6	2,3	Blue	300	~0,2 kg.
SP-IKY/4-10	<b>4</b>	7,0	9,0	16,0	4,4	3,2	2,8	Grey	250	~0,1 kg.
SP-IKY/4-12		8,0	12,0	20,0	4,4	3,2	2,8	Grey	250	~0,2 kg.
SP-IKY/6-12	<b>6</b>	8,0	12,0	20,0	6,3	3,9	3,5	Black	200	~0,2 kg.
SP-IKY/10-12	<b>10</b>	9,0	12,0	21,0	7,6	4,9	4,5	Ivory	100	~0,1 kg.
SP-IKY/16-12	<b>16</b>	10,0	12,0	22,0	8,8	6,2	5,8	Green	50	~0,1 kg.
SP-IKY/16-18		10,0	18,0	28,0	8,8	6,2	5,8	Green	50	~0,1 kg.
SP-IKY/25-16	<b>25</b>	13,0	16,0	29,0	11,2	7,9	7,5	Brown	40	~0,1 kg.
SP-IKY/35-16	<b>35</b>	14,0	16,0	30,0	12,7	8,7	8,3	Beige	20	~0,1 kg.
SP-IKY/50-20	<b>50</b>	16,0	20,0	36,0	15,3	10,9	10,3	Ol. Green	20	~0,1 kg.
SP-IKY/70-20	<b>70</b>	16,0	20,0	36,0	16,0	14,3	13,5	Yellow	15	~0,1 kg.
SP-IKY/95-25	<b>95</b>	18,5	24,5	43,0	18,0	15,6	14,6	Red	8	~0,1 kg.
SP-IKY/120-27	<b>120</b>	20,0	27,0	47,0	20,0	17,7	16,7	Blue	5	~0,1 kg.

FOR THE INSULATED CABLE END-SLEEVES, THE FIRST PART OF THE PRODUCT CODE INDICATES THE DIAMETER AND THE SECOND PART INDICATES THE LENGTH OF THE PRODUCT.

CONFORMED TO GERMAN COLOR STANDARD.

### SK-IKY SPECIFICATIONS

MATERIAL	COPPER
COATING	TIN PLATED
INSULATION	POLYPROPYLENE
CONFORMED TO	DIN 46228



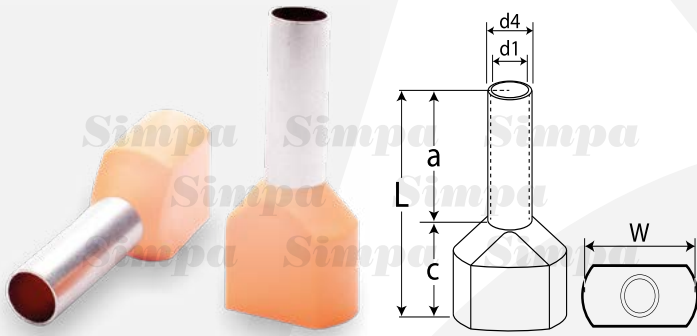

# SP-IKY/2

## INSULATED TWIN CABLE END-SLEEVES

All rights reserved.

Order Code	Cable Section (mm <sup>2</sup> )	Dimensions						Color	Box Pcs.	Box Weight
		c	a	L	W	d4	d1			
SP-IKY/2x0,5-8	<b>2x0,5</b>	7,0	8,0	15,0	5,0	1,8	1,5	White	500	~0,1 kg.
SP-IKY/2x0,75-8	<b>2x0,75</b>	7,0	8,0	15,0	5,5	2,1	1,8	Blue	500	~0,1 kg.
SP-IKY/2x1,0-8	<b>2x1</b>	7,0	8,0	15,0	5,5	2,3	2,0	Red	500	~0,1 kg.
SP-IKY/2x1,5-8	<b>2x1,5</b>	8,0	8,0	16,0	6,4	2,6	2,3	Black	250	~0,1 kg.
SP-IKY/2x1,5-12		8,0	12,0	20,0	6,4	2,6	2,3	Black	250	~0,1 kg.
SP-IKY/2x2,5-10	<b>2x2,5</b>	9,0	10,0	19,0	8,0	3,3	2,9	Grey	200	~0,1 kg.
SP-IKY/2x4-12	<b>2x4</b>	11,0	12,0	23,0	8,8	4,2	3,8	Orange	100	~0,1 kg.
SP-IKY/2x6-14	<b>2x6</b>	12,0	14,0	26,0	9,5	5,3	4,9	Green	75	~0,1 kg.
SP-IKY/2x10-14	<b>2x10</b>	13,0	14,0	27,0	13,6	6,9	6,5	Brown	50	~0,1 kg.
SP-IKY/2x16-14	<b>2x16</b>	17,0	14,0	31,0	19,0	8,7	8,3	Beige	25	~0,1 kg.

FOR THE INSULATED CABLE END-SLEEVES, THE FIRST PART OF THE PRODUCT CODE INDICATES THE DIAMETER AND THE SECOND PART INDICATES LENGTH OF THE PRODUCT.

CONFORMED TO GERMAN COLOR STANDARD.

### SP-IKY/2 SPECIFICATIONS

MATERIAL	COPPER
COATING	TIN PLATED
INSULATION	POLYPROPYLENE



# SP-YK

## INSULATED RING TYPE TERMINALS

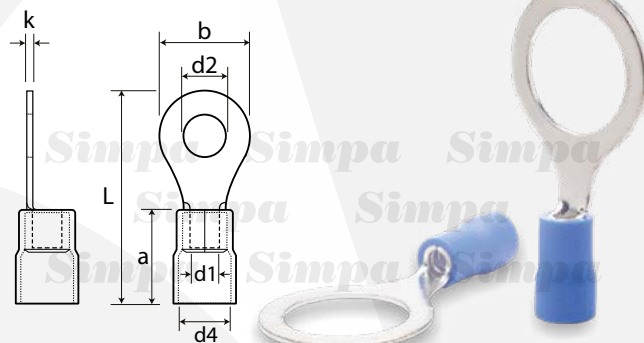

All rights reserved.

Order Code	Cable Section (mm <sup>2</sup> )	Bolt	Dimensions							Color	Box Pcs.	Box Weight
			d1	d4	a	d2	b	L	k			
SP-YK/301	0,5-1,5	M3	1,6	4,3	10,0	3,2	5,7	17,6	0,7	Red	200	~0,2 kg.
SP-YK/401		M4	1,6	4,3	10,0	4,3	8,0	20,8	0,7			
SP-YK/501		M5	1,6	4,3	10,0	5,3	9,8	23,0	0,7			
SP-YK/601		M6	1,6	4,3	10,0	6,4	11,6	26,8	0,7			
SP-YK/801		M8	2,3	4,3	10,0	8,4	11,6	26,8	0,7			
SP-YK/302	1,5-2,5	M3	2,3	4,9	10,0	3,2	6,6	17,5	0,8	Blue	200	~0,2 kg.
SP-YK/402		M4	2,3	4,9	10,0	4,3	8,5	22,0	0,8			
SP-YK/402-S		M4	2,3	4,8	10,0	4,3	6,5	21,0	0,8			
SP-YK/502		M5	2,3	4,9	10,0	5,3	9,5	22,0	0,8			
SP-YK/502-S		M5	2,3	4,8	10,0	5,3	8,5	22,5	0,8			
SP-YK/602		M6	2,3	4,9	10,0	6,4	12,0	27,0	0,8			
SP-YK/802		M8	2,3	4,9	10,0	8,4	12,0	27,0	0,8			
SP-YK/1002		M10	2,3	4,9	10,0	10,5	13,6	30,7	0,8			
SP-YK/1202	M12	2,3	4,9	10,0	13,0	19,2	36,2	0,8				
SP-YK/406	4-6	M4	3,6	6,7	13,0	4,3	9,5	25,8	1,0	Yellow	100	~0,2 kg.
SP-YK/506		M5	3,6	6,7	13,0	5,3	9,5	25,8	1,0			
SP-YK/606		M6	3,6	6,7	13,0	6,4	12,0	31,8	1,0			
SP-YK/806		M8	3,6	6,7	13,0	8,4	15,0	34,0	1,0			
SP-YK/1006		M10	3,6	6,7	13,0	10,5	15,0	34,0	1,0			
SP-YK/1206		M12	3,6	6,7	13,0	13,0	19,2	38,4	1,0			

### SP-YK SPECIFICATIONS

MATERIAL	COPPER
COATING	TIN PLATED
INSULATION	PVC



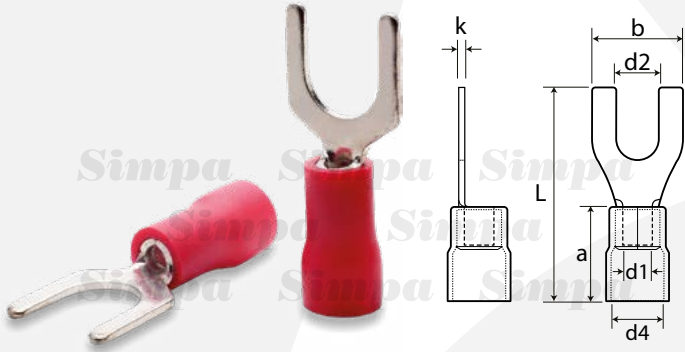

# SK-CK

## INSULATED FORK TYPE TERMINALS

All rights reserved.

Order Code	Cable Section (mm <sup>2</sup> )	Bolt	Dimensions							Color	Box Pcs.	Box Weight
			d1	d4	a	d2	b	L	k			
SP-CK/301	0,5-1,5	M3	1,6	4,3	10,0	3,2	5,7	21,2	0,7	Red	200	~0,2 kg.
SP-CK/401		M4	1,6	4,3	10,0	4,3	8,1	21,2	0,7		200	~0,2 kg.
SP-CK/501		M5	1,6	4,3	10,0	5,3	9,5	21,2	0,7		200	~0,2 kg.
SP-CK/601		M6	1,6	4,3	10,0	6,4	12	27,2	0,7		200	~0,2 kg.
SP-CK/302	1,5-2,5	M3	2,3	4,9	10,0	3,2	5,7	21,2	0,8	Blue	200	~0,2 kg.
SP-CK/402		M4	2,3	4,9	10,0	4,3	8,1	21,2	0,8		200	~0,2 kg.
SP-CK/402-S		M4	2,3	4,8	10,0	4,3	6,4	22,0	0,8		200	~0,2 kg.
SP-CK/502		M5	2,3	4,9	10,0	5,3	9,5	21,2	0,8		200	~0,2 kg.
SP-CK/602	M6	2,3	4,9	10,0	6,4	12,0	27,2	0,8	Blue	100	~0,2 kg.	
SP-CK/406	4-6	M4	3,6	6,7	13,0	4,3	8,3	26,0	1,0	Yellow	100	~0,2 kg.
SP-CK/506		M5	3,6	6,7	13,0	5,3	9,0	26,0	1,0		100	~0,2 kg.
SP-CK/606		M6	3,6	6,7	13,0	6,4	12,0	32,0	1,0		100	~0,2 kg.
SP-CK/806		M8	3,6	6,7	13,0	8,4	14,0	37,0	1,0		75	~0,2 kg.

### SP-CK SPECIFICATIONS

MATERIAL	COPPER
COATING	TIN PLATED
INSULATION	PVC



# SP-FD

## INSULATED RECEPTACLES

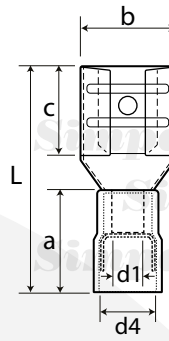

All rights reserved.

Order Code	Cable Section (mm <sup>2</sup> )	Tab Size	Dimensions						Color	Box Pcs.	Box Weight
			d1	d4	a	C	b	L			
SP-FD/1288-5	0,5-1,5	0,5x2,8	1,7	3,8	10,0	6,6	3,8	19,0	Red	200	~0,1 kg.
SP-FD/1288		0,8x2,8	1,7	3,8	10,0	6,6	3,8	19,0			
SP-FD/1488-5		0,5x4,75	1,7	3,8	10,0	6,4	5,6	19,0			
SP-FD/1488		0,8x4,75	1,7	3,8	10,0	6,4	5,6	19,0			
SP-FD/1638		0,8x6,35	1,7	3,8	10,0	7,5	7,4	21,0			
SP-FD/2288	1,5-2,5	0,8x2,8	2,3	4,3	10,0	6,5	3,8	19,0	Blue	200	~0,1 kg.
SP-FD/2488		0,8x4,75	2,3	4,3	10,0	6,4	5,6	19,0			
SP-FD/2638		0,8x6,35	2,3	4,3	10,0	7,5	7,4	21,0			
SP-FD/2778		0,8x8	2,3	4,3	10,0	10	9,0	23,0			
SP-FD/5638	4-6	0,8x6,35	3,4	5,7	13,0	7,5	7,4	25,0	Yellow	100	~0,1 kg.
SP-FD/5956		1,2x9,4	3,4	5,7	13,0	12	10,9	29,6			

### SP-FD SPECIFICATIONS

MATERIAL	BRASS
COATING	TIN PLATED
INSULATION	PVC

# SP-FE

## INSULATED TABS

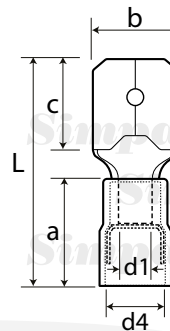

All rights reserved.

Order Code	Cable Section (mm <sup>2</sup> )	Tab Size	Dimensions						Color	Box Pcs.	Box Weight
			d1	d4	a	c	b	L			
SP-FE/1288	0,5-1,5	0,8x2,8	1,7	4,3	10,0	6,5	2,8	17,7	Red	250	~0,1 kg.
SP-FE/1488		0,8x4,75	1,7	4,3	10,0	6,7	4,75	20,0			
SP-FE/1638		0,8x6,35	1,7	4,3	10,0	7,7	6,35	21,0			
SP-FE/2488	1,5-2,5	0,8x4,75	2,3	4,3	10,0	6,7	4,75	20,0	Blue	250	~0,2 kg.
SP-FE/2638		0,8x6,35	2,3	4,3	10,0	7,7	6,35	21,0			
SP-FE/5638	4-6	0,8x6,35	3,4	5,7	13,0	7,7	6,35	25,0	Yellow	100	~0,1 kg.

### SP-FE SPECIFICATIONS

MATERIAL	BRASS
COATING	TIN PLATED
INSULATION	PVC



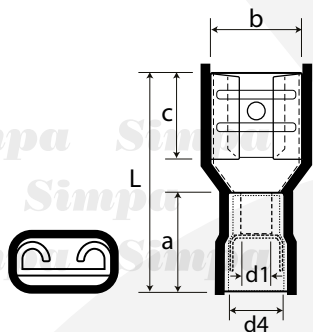

# SP-IFD

## INSULATED RECEPTACLES

All rights reserved.

Order Code	Cable Section (mm <sup>2</sup> )	Tab Size	Dimensions						Color	Box Pcs.	Box Weight
			d1	d4	a	C	b	L			
SP-IFD/1288-5	0,5-1,5	0,5X2,80	1,7	3,8	10,5	6,5	3,2	19,0	Red	100	~0,1 kg.
SP-IFD/1288		0,8X2,80	1,7	3,8	10,5	6,5	3,2	19,0			
SP-IFD/1488-5		0,5X4,75	1,7	3,8	10,5	6,4	5,6	20,0			
SP-IFD/1488		0,8X4,75	1,7	3,8	10,5	6,4	5,6	20,0			
SP-IFD/1638	1,5-2,5	0,8X6,35	1,7	3,8	10,5	7,5	7,4	21,5	Red	100	~0,2 kg.
SP-IFD/2488		0,8X4,75	2,3	4,7	10,5	6,4	5,6	20,0			
SP-IFD/2638	1,5-2,5	0,8X6,35	2,3	4,7	10,5	7,5	7,4	21,5	Blue	100	~0,2 kg.
SP-IFD/5638		4-6	0,8X6,35	3,4	6,2	12,5	7,5	7,4			

### SP-IFD SPECIFICATIONS

MATERIAL	BRASS
COATING	TIN PLATED
INSULATION	PVC

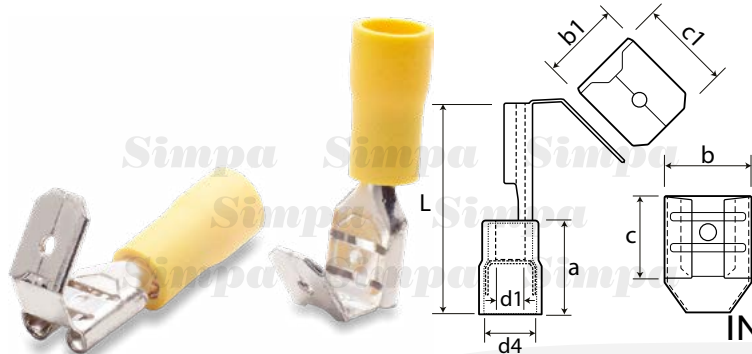

# SP-FEG

## INSULATED RECEPTACLES, MULTIPLE TYPE

All rights reserved.

Order Code	Cable Section (mm <sup>2</sup> )	Tab Size	Dimensions								Color	Box Pcs.	Box Weight
			d1	d4	a	c	c1	b	b1	L			
SP-FEG/1638	0,5-1,5	0,8X6,35	1,7	3,8	10,0	8,0	8,2	7,4	6,35	21,5	Red	100	~0,1 kg.
SP-FEG/2638	0,5-2,5	0,8X6,35	2,3	4,3	10,0	8,0	8,2	7,4	6,35	21,5	Blue	100	~0,2 kg.
SP-FEG/5638	4-6	0,8X6,35	3,4	5,7	13,0	8,0	8,2	7,4	6,35	25,0	Yellow	100	~0,2 kg.

### SP-FEG SPECIFICATIONS

MATERIAL	BRASS
COATING	TIN PLATED
INSULATION	PVC



# SP-IK

INSULATED PIN TYPE CONNECTORS

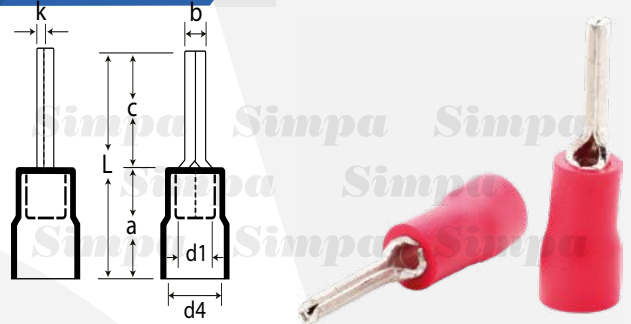

All rights reserved.

Order Code	Cable Section (mm <sup>2</sup> )	Dimensions							Color	Box Pcs.	Box Weight
		d1	d4	a	c	b	L	k			
SP-IK/0,5-1,5	<b>0,5-1,5</b>	1,7	4,3	10,0	10,0	1,9	20,0	0,75	Red	200	~0,2 kg.
SP-IK/1,5-2,5	<b>1,5-2,5</b>	2,3	4,9	10,0	12,0	1,9	22,0	0,8	Blue	200	~0,2 kg.
SP-IK/4-6	<b>4-6</b>	3,4	6,7	13,0	12,5	2,8	25,5	1,0	Yellow	100	~0,2 kg.

## SP-IK SPECIFICATIONS

MATERIAL	COPPER
COATING	TIN PLATED
INSULATION	PVC

# SP-IBU

INSULATED BLADE TYPE TERMINALS

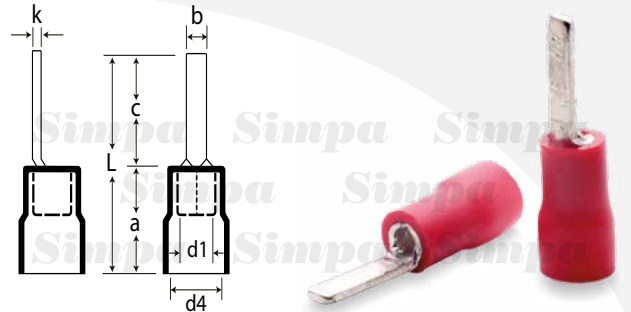

All rights reserved.

Order Code	Cable Section (mm <sup>2</sup> )	Dimensions							Color	Box Pcs.	Box Weight
		d1	d4	a	c	b	L	k			
SP-IBU/101-14	<b>0,5-1,5</b>	1,7	3,8	10,0	14,0	3	24,0	0,75	Red	200	~0,2 kg.
SP-IBU/102-18	<b>1,5-2,5</b>	2,3	4,9	10,0	18,0	2,2	28,0	0,75	Blue	200	~0,2 kg.

## SP-IBU SPECIFICATIONS

MATERIAL	BRASS
COATING	TIN PLATED
INSULATION	PVC

# SP-IEM

INSULATED BUTT CONNECTORS

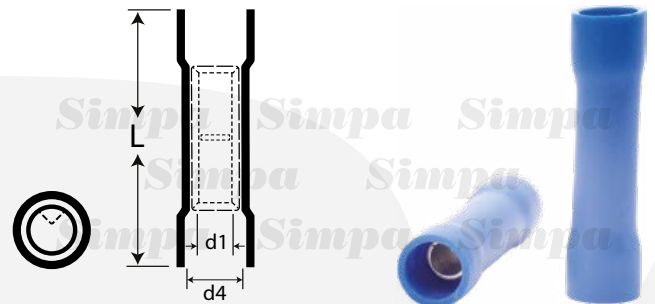

All rights reserved.

Order Code	Cable Section (mm <sup>2</sup> )	Dimensions			Color	Box Pcs.	Box Weight
		d1	d4	L			
SP-IEM/251	<b>0,5-1,5</b>	1,7	4,0	25,0	Red	150	~0,1 kg.
SP-IEM/252	<b>1,5-2,5</b>	2,3	4,9	16,0	Blue	150	~0,3 kg.
SP-IEM/256	<b>4-6</b>	3,6	6,7	20,5	Yellow	100	~0,2 kg.

## SP-IEM SPECIFICATIONS

MATERIAL	COPPER
COATING	TIN PLATED
INSULATION	PVC



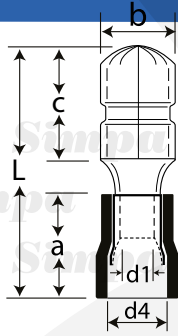

# SP-ET

## INSULATED MALE BULLET CONNECTORS

All rights reserved.

Order Code	Cable Section (mm <sup>2</sup> )	Dimensions						Color	Box Pcs.	Box Weight	
		d1	d4	a	c	b	L				
SP-ET/1040	0,5-1,5	1,7	3,8	10,0	11,0	4,0	21,0		Red	200	~0,2 kg.
SP-ET/2040		2,3	4,7	10,0	11,0	4,0	21,0		Blue	200	~0,2 kg.
SP-ET/2050	1,5-2,5	2,3	4,7	10,0	11,0	5,0	21,0		Blue	200	~0,2 kg.
SP-ET/5050	4-6	3,4	6,2	13,0	12,0	5,0	25,0		Yellow	100	~0,1 kg.

### SP-ET SPECIFICATIONS

MATERIAL	BRASS
COATING	TIN PLATED
INSULATION	PVC

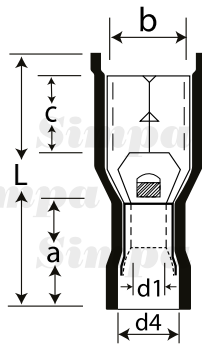

# SP-DT

## INSULATED FEMALE BULLET CONNECTORS

All rights reserved.

Order Code	Cable Section (mm <sup>2</sup> )	Dimensions						Color	Box Pcs.	Box Weight	
		d1	d4	a	c	b	L				
SP-DT/1040	0,5-1,5	1,7	3,8	10,5	7,0	4,0	24,5		Red	100	~0,2 kg.
SP-DT/2040		2,3	4,7	10,5	7,0	4,0	24,5		Blue	100	~0,2 kg.
SP-DT/2050	1,5-2,5	2,3	4,7	10,5	7,0	5,0	25,5		Blue	100	~0,2 kg.
SP-DT/5050	4-6	3,4	6,2	10,5	7,0	5,0	29,5		Yellow	100	~0,2 kg.

### SP-DT SPECIFICATIONS

MATERIAL	BRASS
COATING	TIN PLATED
INSULATION	PVC



## TECHNICAL DATA

### Assembly Instructions for Cable Lugs and Connectors

1. Strip conductor according to insertion depth (+10% because of length changing of crimped sleeve)
2. Conductor ends must be cleaned with a cloth or brush or before assembly.
3. Insert conductor fully into cable lug or connector.
4. Paying attention crimping direction, crimp the cable lug or connector using the appropriate tools. The crimping direction for cable lugs and connectors is indicated in the illustration below.
5. After crimping, wipe away excess compound forced out from aluminium cable lugs and connectors.

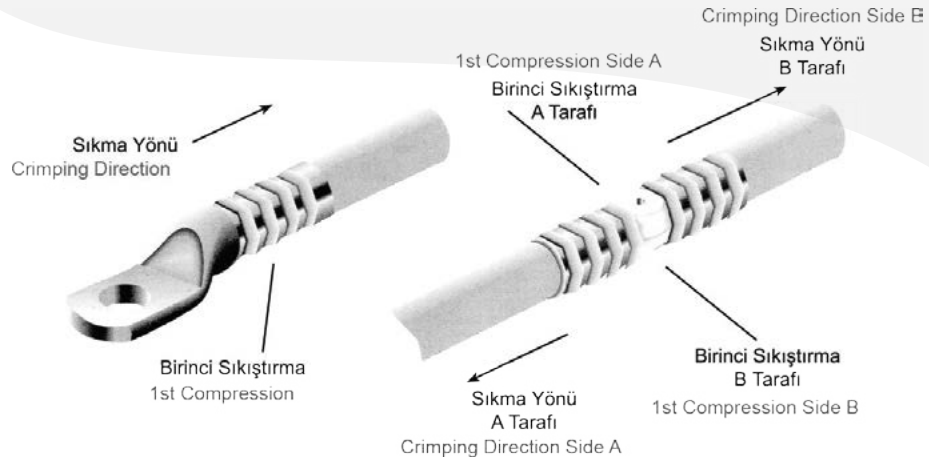

We Recommend the Following Number of Compression for Individual Cable Sections

Cable Section (mm <sup>2</sup> )	Tubular Cable Lugs 5mm Crimping die	Wide Crimping dies	DIN Cable Lugs 5mm Crimping die	Wide Crimping dies	Aluminium Cable Lugs 7mm Crimping die	Wide Crimping dies
6	1		2			
10	1		2			
16	1	1	2	1	4	2
25	2	1	2	1	4	2
35	2	1	2	1	5	2
50	2	1	3	1	5	2
70	2	1	3	1	6	3
95	2	1	4	2	6	3
120	2	1	4	2	6	3
150	2	1	4	2	6	3
185	1	1	4	2	6	3
240	4	2	5	2	8	3
300	4	2	5	2	8	3
400	4	2		3		4
500				3		4
625				3		
800				3		
1000			4	2		

## NOTES

---

A series of horizontal dotted lines for writing notes, spanning the width of the page.

# *Simpa*<sup>®</sup>

## **ELEKTRİK MALZEMESİ SAN. ve TİC. A.Ş.**

DES Sanayi Sitesi 105 Sokak B11 Blok No:16

Yukarı Dudullu - İstanbul

Tel :+90 (216) 415 38 97

:+90 (216) 499 69 62

Fax :+90 (216) 420 68 82

[info@simpaelektrik.com.tr](mailto:info@simpaelektrik.com.tr)

[www.simpaelektrik.com.tr](http://www.simpaelektrik.com.tr)