

PARÇA KODU PART CODE	PARÇA ADI PART NAME	ERKEK TERMINAL MALE TERMINAL	a ÖLÇÜSÜ (AYAR) a MEASURE (SET)	s ÖLÇÜSÜ (KALINLIK) s MEASURE (THICKNESS)	MALZEME MATERIAL	KAPLAMA COATING
TD 2152.50 RP	YASSI DİŞİ FİŞ TEK NOKTALI 2.8 (0.50) =RP=	0.50	0.40±0.05	-----	(CuZn30) Pirinç / Brass	-----
TD 2152.50 RPK	YASSI DİŞİ FİŞ TEK NOKTALI 2.8 (0.50) =RPK=	0.50	0.40±0.05	-----	(CuZn30) Pirinç / Brass	Kalay / Sn (3-5µ)
TD 2152.80 RP	YASSI DİŞİ FİŞ TEK NOKTALI 2.8 (0.80) =RP=	0.80	0.70±0.05	-----	(CuZn30) Pirinç / Brass	-----
TD 2152.80 RPK	YASSI DİŞİ FİŞ TEK NOKTALI 2.8 (0.80) =RPK=	0.80	0.70±0.05	-----	(CuZn30) Pirinç / Brass	Kalay / Sn (3-5µ)

A-A Kesiti

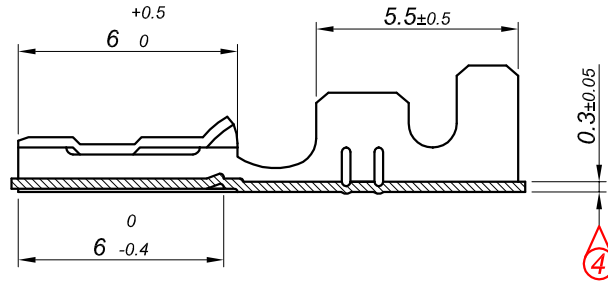

C-C Kesiti

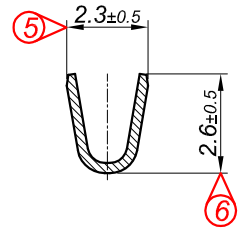

B-B Kesiti

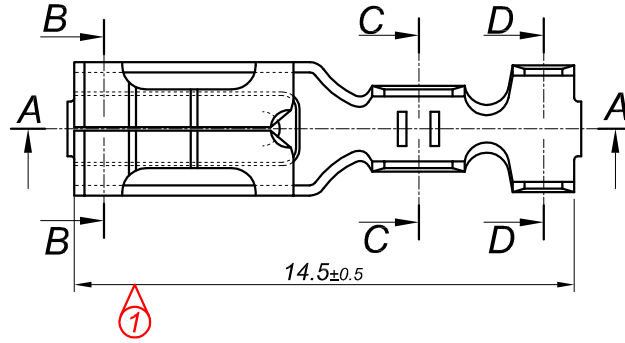
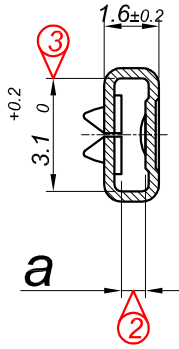

D-D Kesiti

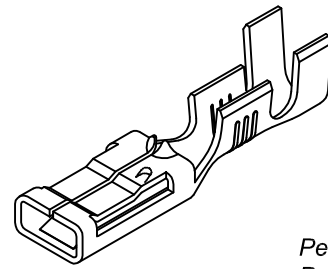
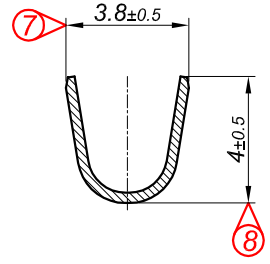

Perspektif
Perspective

Kalıp çıkış yönü
Mold output direction ← → Makara açılım yönü
Reel opening direction

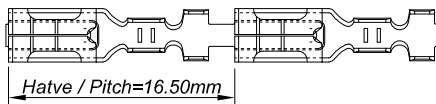

Ölçek
Scale : 2 / 1

Kablo Kesiti

Wire Section : 0.5 - 1 mm²

Resim üzerinden ölçü almayınız
do not measure on drawing

Tarih / Date	20.03.2013	İmza / Signature	Ölçek / Scale			
Çizen / Desing	M.Yağcı					
Onay / Approval	S.Gölcük		5 / 1	No	Değişiklik / Revision	Tarih/Date



Parça Adı:
Part Name YASSI DİŞİ FİŞ TEK NOKTALI 2.8

Parça Kodu:
Part Code TD 2152